

# AQUALISA VISAGE Q™

VSQ.A2.BV.  
DVFW.20

WITH ADJUSTABLE HEAD AND WALL FIXED DRENCHER - GRAVITY PUMPED

## DIMENSIONAL DRAWINGS

### FIXED WALL DRENCHER

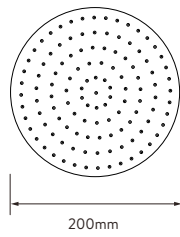
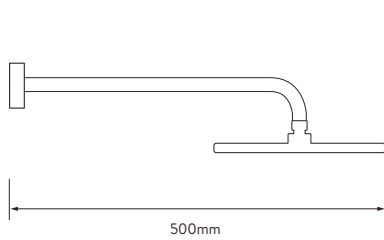

### CONTROLLER

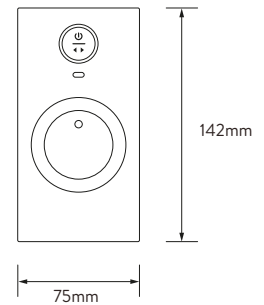

### SHOWER RAIL KIT

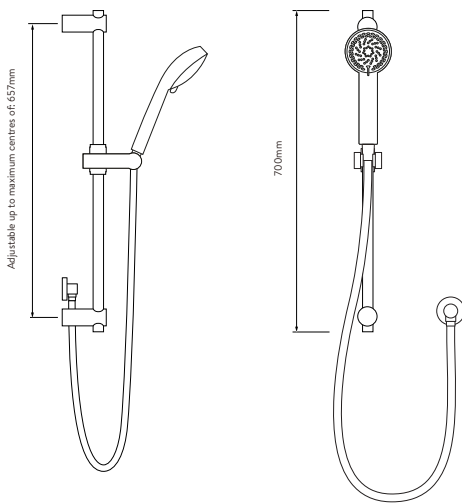

### SHOWER HEAD

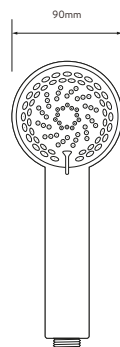

### AQUALISA SMARTVALVE™

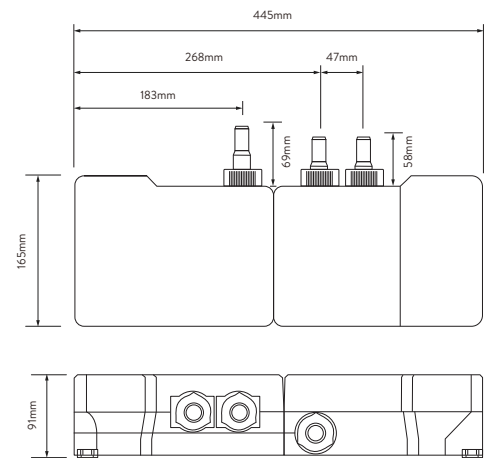

### DIVERTER

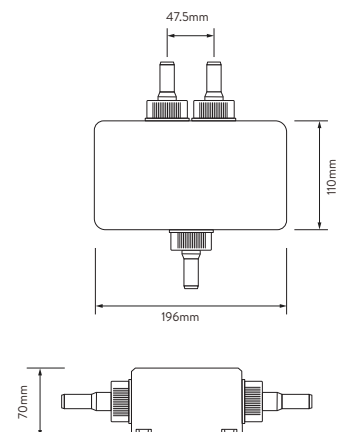

### SHOWER HOSE

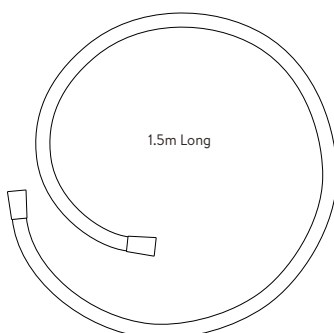

# AQUALISA

## VISAGE Q™

VSQ.A2.BV.  
DVFW.20

WITH ADJUSTABLE HEAD AND WALL FIXED DRENCHER - GRAVITY PUMPED

### TECHNICAL SPECIFICATIONS

Minimum pressure requirements	Aqualisa SmartValve™ must be sited no higher than the base level of the cold water cistern
Maximum pressure requirements	1 bar (Gravity)
Aqualisa SmartValve™ inlet fitting connections	15mm push fit fittings, valve inlet centres 48mm, inlet supply positions – hot right, cold left
Aqualisa SmartValve™ and diverter outlet connections	15mm push fit
Permissible Aqualisa SmartValve™ and diverter siting locations	Loft, airing cupboard, under bath
Supply temperature	Cold inlet temperature 1°C (minimum) Cold inlet temperature 15°C (maximum) Hot inlet temperature 65°C (maximum)
Water system	Gravity
Blended outlet temperature settings	Factory mid set blend temperature 45°C, adjustable temperature setting – minimum 35°C, maximum 55°C
Electrical requirements - SmartValve™ to mains	Switched fused spur 3amp, processor main cable length 2m, required voltage 230 – 240V
Electrical requirements - Controller to SmartValve™	Low voltage data cable length 10m
Electrical requirements - Diverter to SmartValve™	Low voltage data cable length 2m
Data cable voltage	5V
Features	One touch start/stop control
	LED display indicates when pre-selected temperature has been reached
	Wi-Fi & App compatible – control your product with your smart phone and smart home device e.g. Alexa
	App functions include start/stop, shower timer, user dashboard, usage tracker and help & support
	Aqualisa SmartValve™
	Digital diverter technology
	90mm, 4 spray patterns, including an eco-setting
Compatible with wired remote control	
Guarantee period	5-year guarantee - shower unit
	2-year guarantee - shower head and kit
Approvals	CE Marking
	BEAB