

---

# BRISTAN

---

TAPS & SHOWERS

## Installation Instructions and User Guide

Gallery Rapid Boiling  
3-in-1 Sink Mixer Chrome

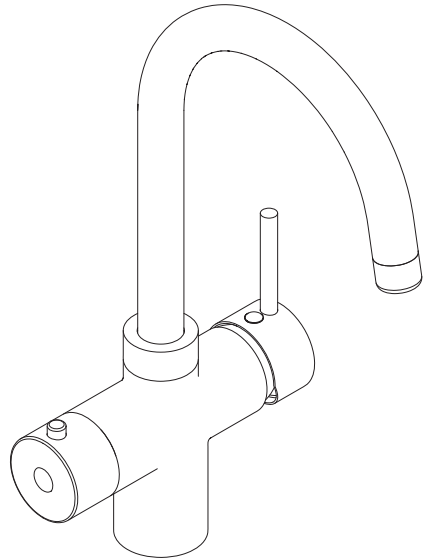

### Models Covered:

GLL RAPSNK3 C

**Please keep this booklet for future  
reference.**

Installer, when you have read these  
instructions please ensure you leave  
them with the user.

# Contents

Thank you for choosing Bristan, the UK's leading tap and shower expert.

We have designed this product to be easy to install and use. It has also been designed and tested in the UK to all of the relevant British Standards, and conforms to CE Regulations.

These instructions are for your guidance to a safe and successful installation, so please read them thoroughly and retain for future reference.

We recommend the installation is carried out by a suitably qualified person and must conform with current I.E.E Wiring Regulations (BS7671) and Building Regulations (Part P and Part G).

## Contents

• Important Safety Information	<b>3-4</b>
• Specification	<b>5</b>
• Installation Requirements	<b>6-7</b>
• Installation	<b>8-9</b>
• Preparation for Use	<b>9</b>
• Operation	<b>10-11</b>
• General Cleaning	<b>11</b>
• Maintenance	<b>12-13</b>
• Troubleshooting	<b>14</b>
• Notes	<b>15</b>













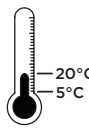
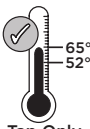
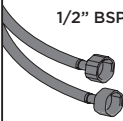





## Important Safety Information

- **Please read these instructions thoroughly and retain for future use.**
- All products manufactured and supplied by Bristan are safe provided they are installed, used correctly and receive regular maintenance in accordance with these instructions.
- **If you are in any doubt about your ability to install this product safely you must employ the services of an experienced qualified plumber/electrician.**
-  **Warning:** The Boiling Water Tank is intended for domestic use only. Do not install the unit outdoors or where it might be subjected to damp or freezing conditions.
- Check the power rating of the Boiling Water Tank is suitable for the power rating of the electrical circuit that it is being installed on
- Check that no parts are missing or damaged on the Boiling Water Tank or Tap as per the instructions. If parts are missing or damaged, do not install and contact Customer Services
- Ensure the Boiling Water Tank is installed in a room/environment with an access point. This is required to prevent condensation forming within the unit. Keep away from direct sunlight.
- This Boiling Water Tank is only intended for use with compatible Bristan Boiling Water Taps. Using this tank with any other tap will invalidate the guarantee.
- Do not attempt to open or modify the Boiling Water Tank as this will invalidate the guarantee.

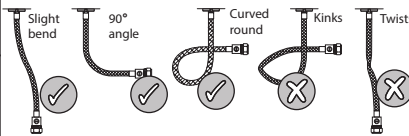
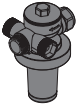
## Important Safety Information

- The filter supplied has to be replaced every six months for protection of your Boiling Water Tank. Failure to do so will invalidate your guarantee.
- To protect against electric shock, do not place the cord, plugs or Boiling Water Tank near or in water/ other liquids. Do not operate the appliance or touch the plug with wet hands.
- Only use the power lead supplied with the product. If the power lead is damaged, stop using immediately and contact Customer Services for a replacement. Do not attempt to fix as this can result in serious injury or death.
- Do not remove the earthing terminal, reconstruct the plug, or disassemble the main box or any part for the power.
- The appliance must be installed vertically with the inlet and outlet connections at the top of the unit. Ensure that front of the unit is visible and the touch-screen can be easily reached.
-  **Warning:** This appliance is not intended for use by children or persons with reduced physical, sensory or mental capabilities or lack of experience and knowledge; unless they have been given supervision or instruction concerning use of appliance in a safe way, and understand the hazards involved.
- Children should not play with the appliance. Cleaning and maintenance should not be undertaken by children without supervision.
- Turn off all controls before unplugging. Unplug by grasping the plug, not the cable.

# Specification

Specifications		Inlet Water Temperatures		Inlet Connections	Tank Capacity				
<b>Working Pressures</b> <b>Hot</b> Min: 0.5 Bar  <b>Max:</b> 5.0 Bar <b>Cold</b> Min: 1.5 Bar  <b>Max:</b> 3.0 Bar <b>Maximum Static Pressure:</b> 3.0 Bar		<b>Cold Water Supply</b>  Min: 5°C Max: 20°C <b>IMPORTANT</b> Suitable for high pressure systems only	<b>Hot Water Supply</b>  Min: 52°C Max: 65°C <b>Tap Only</b> 7 Temperature Settings Min: 75°C Max: 98°C	1/2" BSP 	2.4L 				
<b>Recommended Usage</b> <table border="1"> <tr> <td> <b>Domestic</b>   </td> <td> <b>Heavy Commercial</b>   </td> </tr> <tr> <td> <b>Light Commercial</b>   </td> <td> <b>Healthcare</b>   </td> </tr> </table>		<b>Domestic</b> 	<b>Heavy Commercial</b> 	<b>Light Commercial</b> 	<b>Healthcare</b> 	<b>Flexible Tails</b> 		<b>Supply Requirements</b> The Pressure Reducing Valve (PRV) supplied is pre-set at 3bar and is required on the Domestic Cold Supply. 	
<b>Domestic</b> 	<b>Heavy Commercial</b> 								
<b>Light Commercial</b> 	<b>Healthcare</b> 								
				<b>Electrical Requirements</b>  230-240V AC 1.4-1.5kW 50 Hz- IPX4 Protection Conforms to CE Regulations					

## Prior to Installation

All products manufactured and supplied by Bristan are safe to use provided they are installed, operated correctly and receive regular maintenance in accordance with these instructions.

This product has been designed to comply with the Water Supply (Water Fittings) Regulations 1999 and current bylaws. For full Installation Requirements & Notes (IRN) please visit [wras.co.uk/directory](http://wras.co.uk/directory).

Remove all packaging and check the contents for damage before starting any installation.

Fitting isolation valves (not supplied) to the inlet feeds is required as close as is practical to the inlet connections for ease of maintenance.

Before installing this product the water supply must be thoroughly flushed in order to remove any swarf, solder etc.

Ensure an electric socket is near the place of installation; if a socket needs to be installed, please request the services of a qualified electrician.

## Pack Contents

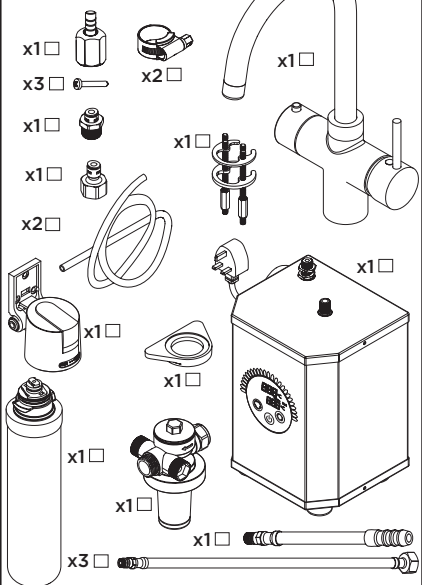

## Tools You'll Need



Pencil



Flat-head Screwdriver



Drill



Cross-head Screwdriver



Pipe Cutter



Adjustable Spanner



Pipe & Wire Detector



Pliers

Need help? Give us a call on **0330 026 6273** and speak to one of our trained advisors.

# Installation Requirements

## Positioning the Boiling Water Tank

Place the tank in a suitable, well ventilated location that will not fall below 0°C.

Ensure that the tank is installed vertically on a level surface with adequate space around the tank. Keep away from direct sunlight.

We recommend installing a Drain Pan and waste (not supplied) to protect against water damage and for ease of emptying the tank.

Also ensure that the Filter is in an easily accessible place for replacement purposes.

Ensure that the tap tails and filter connections can reach the connection points.

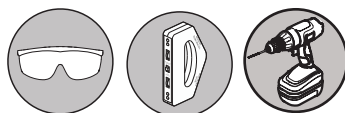
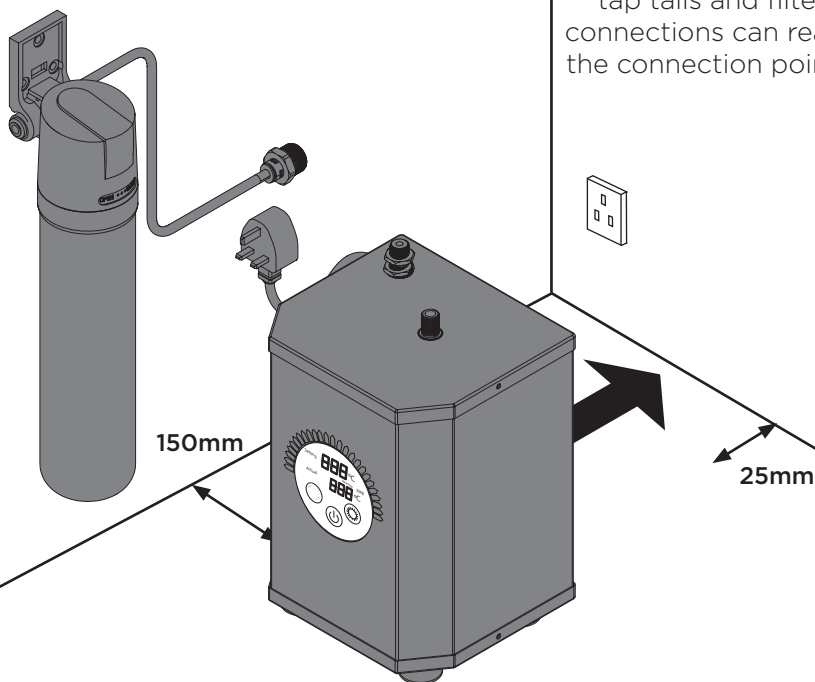

# Installation Requirements

## Connection Diagram



### IMPORTANT

The PRV, filter and isolation valves, are required for optimum performance and maintenance of your product

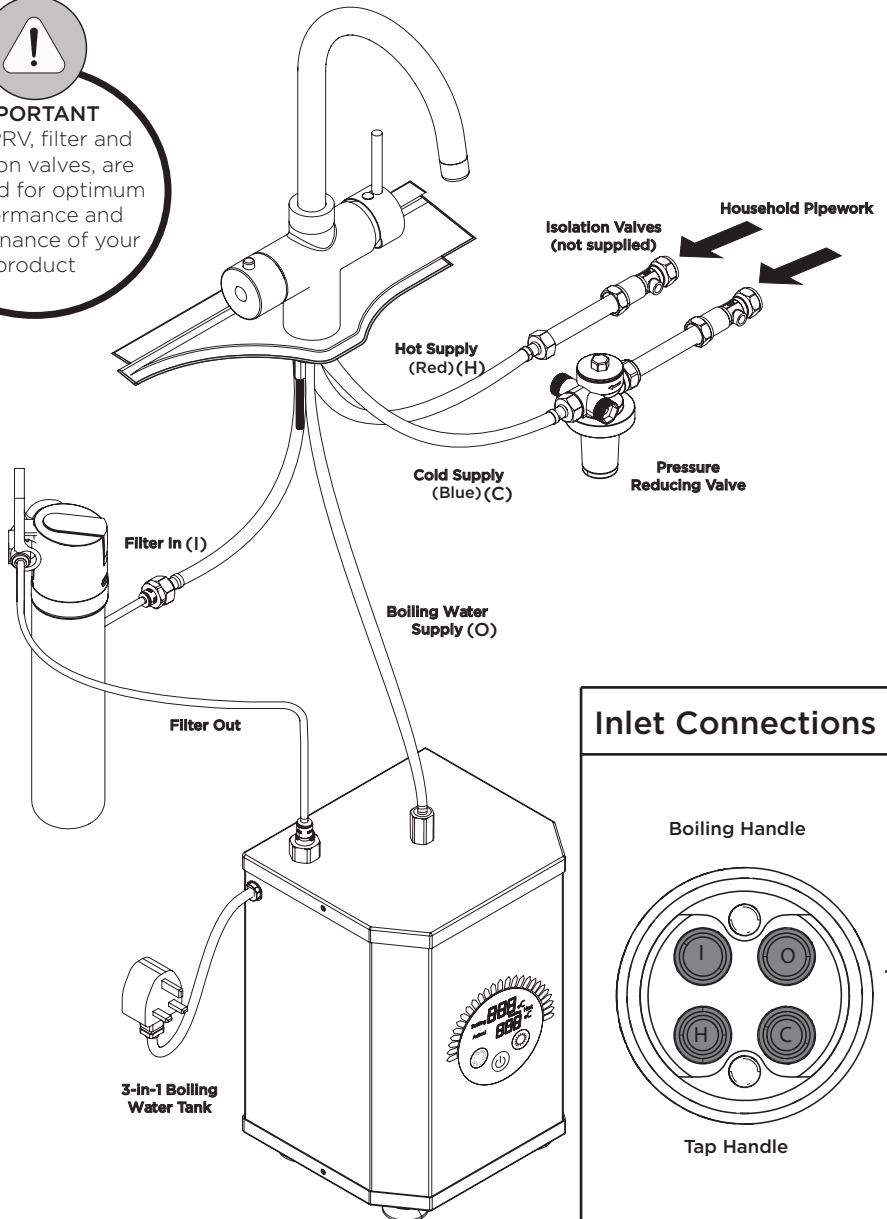

# Installation

1

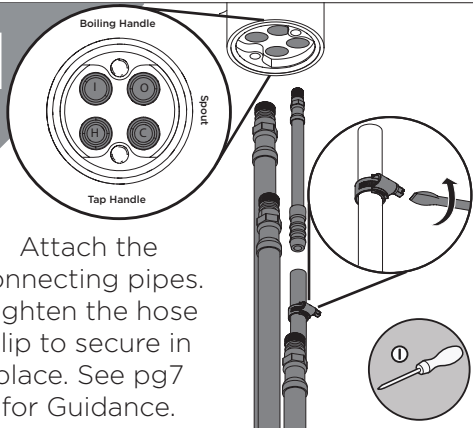

Attach the connecting pipes. Tighten the hose clip to secure in place. See pg7 for Guidance.

2

Feed the pipes through the sink hole and place the tap body.

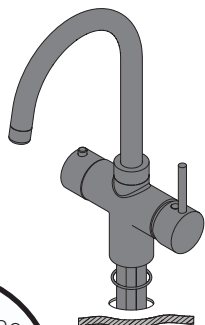

3

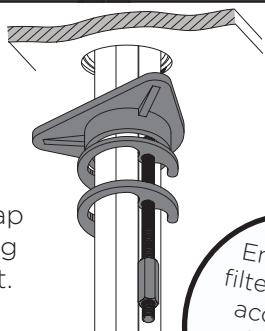

Secure the tap in place using the fixing kit.

4

Position the Boiling Water Tank in a suitable location. (See Installation Requirements)

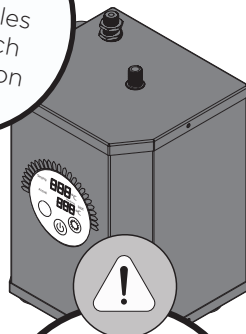

Ensure the tap tails and cables can reach connection points.

Ensure the filter is easily accessible for filter replacements

### IMPORTANT

Do not tamper with the PRV as this will affect the performance of your tap.

5

Fix the filter mounting bracket to the wall/surface.

Ensure easy access, and that the connecting pipes from the tap and tank can reach.

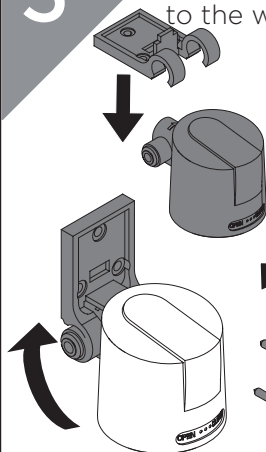

6

### IMPORTANT

A single check valve on the cold supply is required as per IRN R150

Connect the domestic hot and cold water supplies.

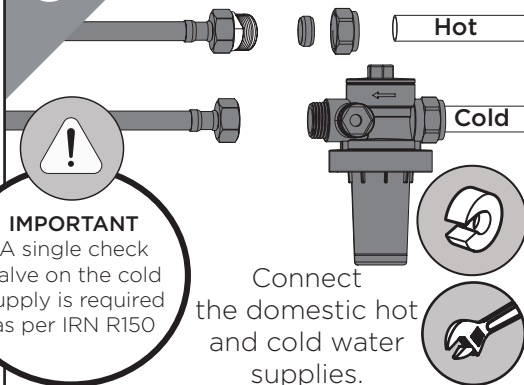

8

**Need help?** Give us a call on **0330 026 6273** and speak to one of our trained advisors.



# Installation

7

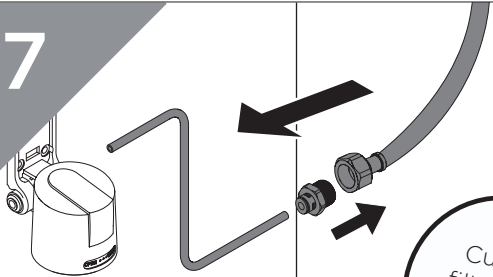

Connect the filter inlet connections from the boiling water tap to the filter.

8

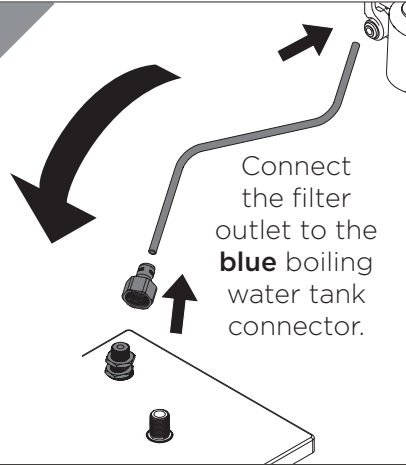
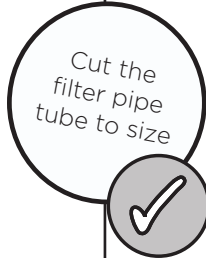

Connect the filter outlet to the **blue** boiling water tank connector.

## IMPORTANT

Ensure the plastic shroud covers the silicon hose connector. This is a safety feature to prevent accidental scalding.



9

Screw the hose adaptor on to the **red** Boiling Water Tank connector. Push on the silicon hose trimming off any excess. Secure in place with the hose clip.

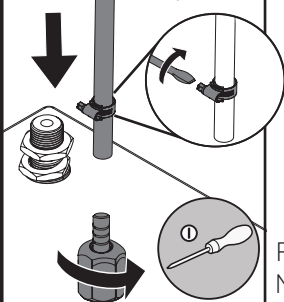

10

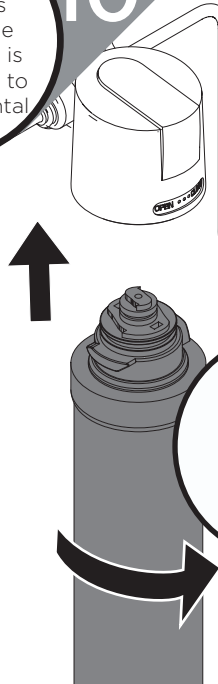

Attach the Filter Sump to the Mounting Bracket.

## Preparation for Use

Place a jug under the spout and expel all air from the system. Check connections for any leaks.

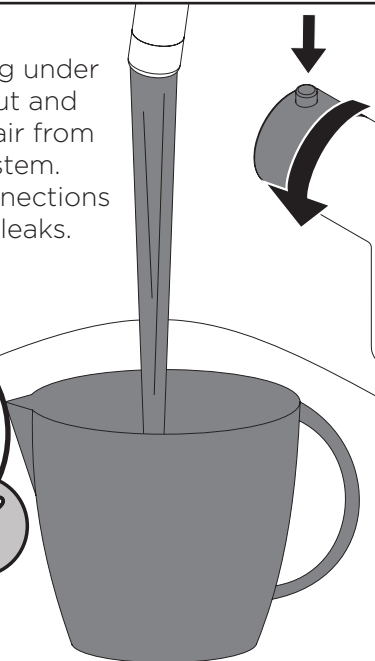
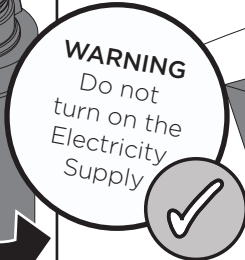

Run off at least 20 litres of water from the Boiling Water handle, resting the system every 30 seconds.

**Your Tap is now Ready for Use.**

# Operation

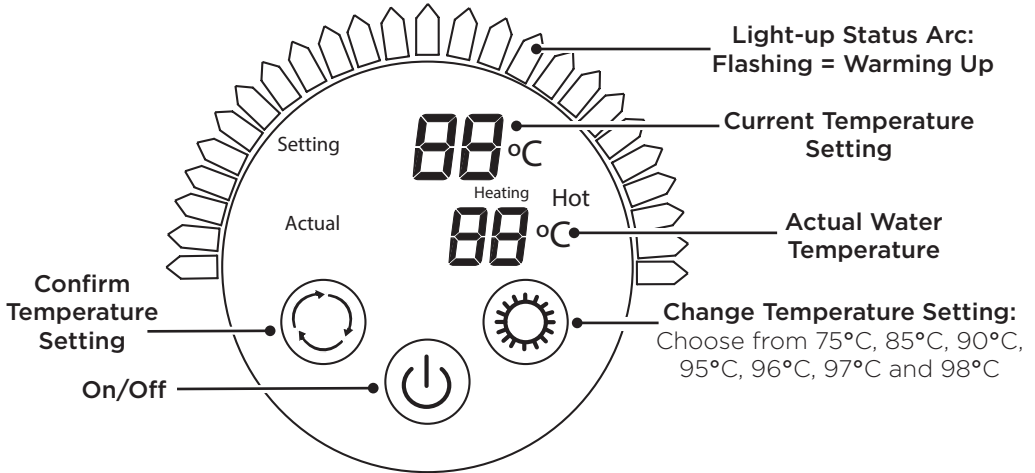

## Start-Up/Change Temperature

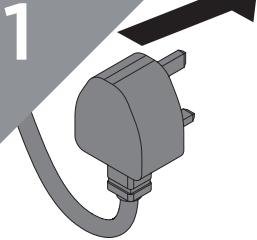

Plug in the Power Supply.  
Hold the On/Off Button until the display lights up.

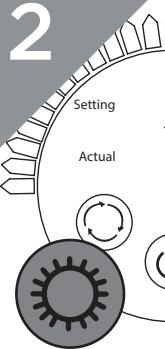

Press the Change Temperature Button until your desired temperature setting is displayed.

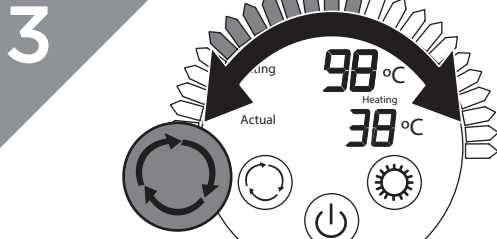

Press Confirm. The status arc will light up and move to indicate the water is heating up.

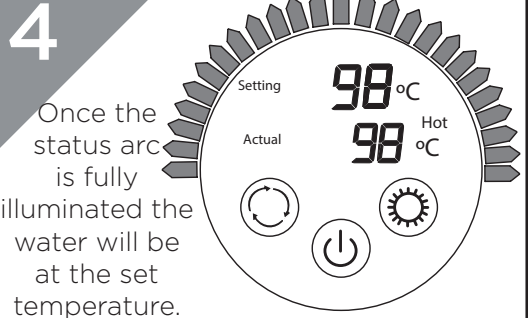

Once the status arc is fully illuminated the water will be at the set temperature.

# Operation

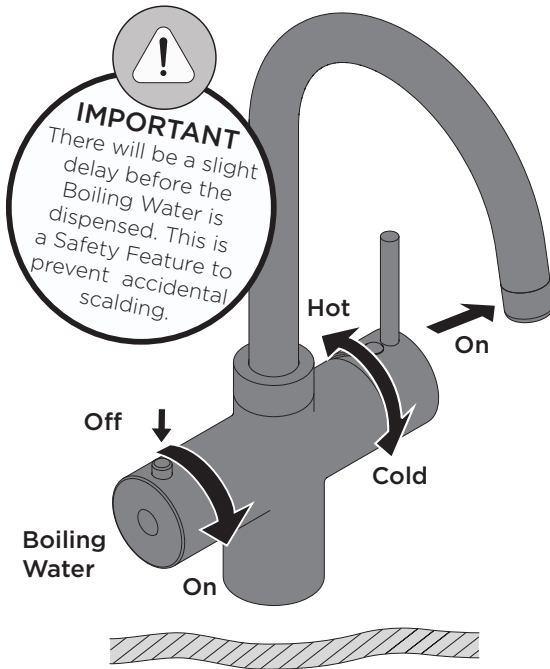

## Optimum Temperatures

Temperature	Suitable For
75°C	Green Tea
85°C	Instant Coffee/ Oolong Tea
90°C	Oolong Tea/ Brewing Coffee
95°C	Brewing Coffee
96°C	
97°C	Black Tea/Herbal Tea
98°C	

## Operation - Boiling Water

1

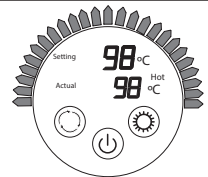

Set up the Boiling Water Tank temperature (see pg10).

2

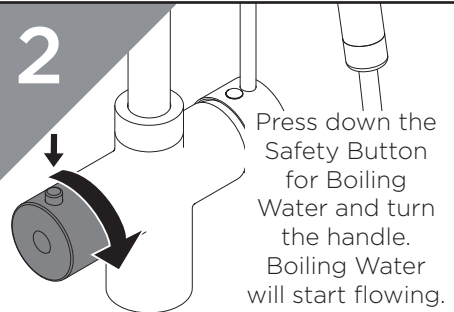

3

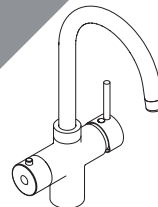

Once the required amount is released, let go of the Safety Button and return the handle to the off position.

## General Cleaning

Your fitting has a high quality finish and should be treated with care to preserve the visible surfaces. All surfaces will wear if not cleaned correctly, the only safe way to clean your product is to wipe with a soft damp cloth. Stains can be removed using washing up liquid.

All bath cleaning powders and liquids will damage the surface of your fitting, even the non-scratch cleaners.

**Note:** Never use abrasive detergents or disinfectants or those containing alcohol, hydrochloric acid or phosphoric acid.

# Maintenance

## Cleaning Outlet

1



**IMPORTANT**

Isolate the water supply before starting!

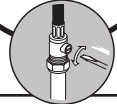

Unscrew the aerator casing and hold the aerator.

2

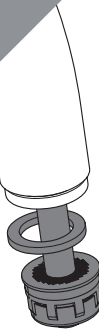

Using a suitable solution, scrub and wash the aerator until fully de-scaled. Rinse thoroughly.

3



Return the aerator ensuring the washer is in place. Screw on the casing.

## Emptying the Boiling Water Tank

1

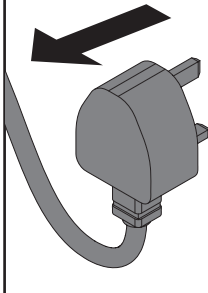

Switch off the Boiling Water Tank and unplug, leave until the tank is cool.

2

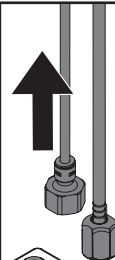
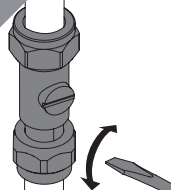

Isolate the water supply and disconnect the Boiling Water Tank.

Empty the tank if the tap isn't in use for long periods of time.

3



**WARNING**

Ensure the tank is cool to touch!

Tip upside down to empty the tank.

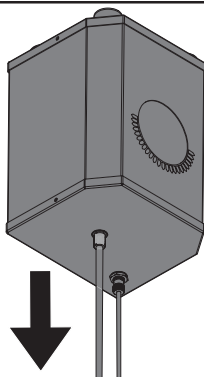

4

Follow the Installation Steps from Step 4 in order to re-connect the Boiling Water Tank.

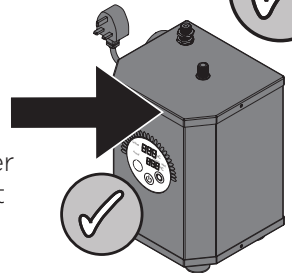

# Maintenance

## Changing the Filter

1



Switch off the Boiling Water Tank.

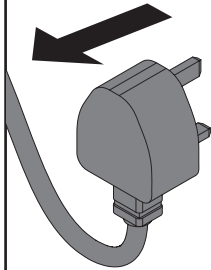

2

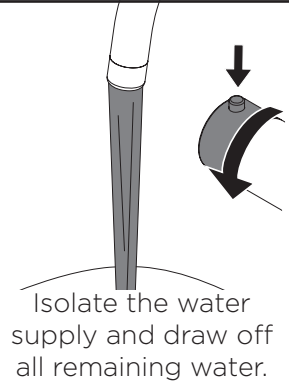
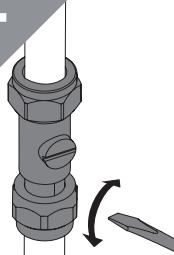

3

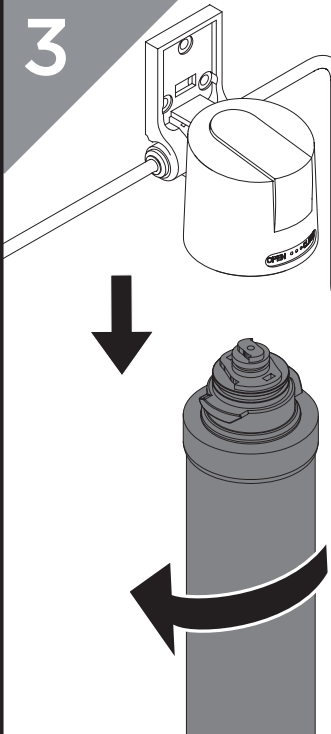

Place a small bowl underneath the filter sump and remove it.

4

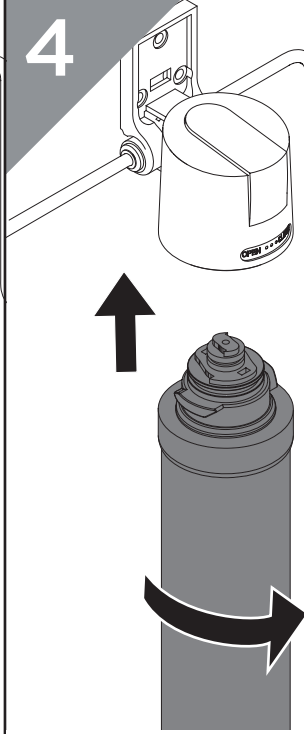

Dispose of the old filter and replace with the new filter.

5



### Preparation for Use

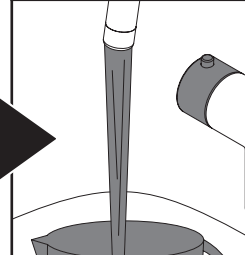

Turn on the water supply. Follow the Preparation for Use section to re-prime the filter.

### Spare Parts



To replace any spare parts for your tap, why not scan the QR Code or visit [www.bristan.com](http://www.bristan.com) and search for your product.

# Maintenance Schedule

We have included this maintenance schedule in order to help keep track of when to replace your filter; which can be ordered using **RAP FILT** on the Bristan website. Please ensure your plumber fills in the date of installation.

Date Installed/Replaced	Date Due for Replacement
___/___/_____	

## Notes

# Troubleshooting

Symptom	Cause	Remedy
'99' flashing in the 'Set Temperature' display.	Boiling Water Tank is empty at first switch-on.	Follow the Preparation for Use section.
	Boiling Water Tank isn't holding water.	Check connections for any leaks/blockages. Contact Customer Services.
E3 Error Code in the 'Set Temperature' display.	No Water in Tank after first use	
E4 Error Code in the 'Set Temperature' display.	Thermistor Fault	Please Contact Customer Services.
Water/Steam is spitting from the spout.	Unit is boiling.	Turn the Instant Hot Water Tap handle and release the water.
		Adjust the water temperature to a lower setting - See Operation.
		Check the aerator isn't blocked.
		Follow the Preparation for Use section to remove any airlocks.
Water is not hot.	The Boiling Water Tank is unplugged.	Make sure the appliance is plugged in and the display is lit.
	The Boiling Water Tank is not switched on.	Follow the Start-Up steps (pg10) and wait until the Status Arc is fully lit before use.
	Water hasn't finished heating up.	
Water is too hot.	The water temperature is set too high.	Set the water temperature to a lower setting - See Operation.
Water is dripping from the spout.	Residual water tension.	This is caused the build up of water in the tap body and is normal for a short period of time.
	The Expansion Chamber isn't draining correctly.	Draw off 500ml of water to clear and prime the system. Avoid drawing off less than 150ml per use.
	Blocked spout.	See Maintenance Section to Clean Aerator.
Slow flow from the spout.	Water Filter needs changing.	Refer to the Maintenance Steps to change the water filter. This must be changed every 6 months or it will invalidate the guarantee.
Water doesn't flow straight away.	This appliance is designed for non-pressurised operation. There will be a slight delay until the instant hot water appears.	After a large volume of water has been drawn off, there may be a slightly longer delay in water appearing from the Instant Hot Water spout.
No water flowing.	Closed/Partially closed isolation valves.	Make sure isolation valves are fully open.
	Flexible tails kinked/blocked.	Ensure pipes are not twisted or kinked to restrict flow.
	Boiling Water Tank may be blocked.	Contact Customer Services.

**Need help?** Give us a call on **0330 026 6273** and speak to one of our trained advisors. **15**

**Issue: D4**

**Part Number: FI GLL RAPSNK3 C**

# **BRISTAN**

TAPS & SHOWERS

**Bristan Group Ltd.**

Birch Coppice Business Park  
Dordon  
Tamworth  
Staffordshire  
B78 1SG

**Web:** [www.bristan.com](http://www.bristan.com)

**Email:** [enquire@bristan.com](mailto:enquire@bristan.com)

**A Masco Company**

At Bristan, we want to make things as easy as possible for our customers. That's why we offer solid guarantees on all our products, effective from the date of purchase, to give you peace of mind. To start your free guarantee simply scan the QR code and register your product. Alternatively visit [www.bristan.com/register](http://www.bristan.com/register).

For any other queries, please call our Customer Service on 0330 026 6273 where our expert team of advisors will be able to offer you any help and advice.

For full guarantee terms and conditions visit [www.bristan.com/guarantees](http://www.bristan.com/guarantees).



*We Know & We Care*