

mira
Orbis



Mira Orbis Thermostatic Electric Shower
Installation and User Guide

These instructions are to be left with the user

Contents

- Patents and Design Registration 2
- Introduction 3**
- Important Safety Information 4**
 - Warning! 4
 - Caution! 5
- Pack Contents Checklist 6**
- Specifications 7**
- Installation Requirements 7**
- Installation 10**
 - Installation of Mira Orbis 10
- Commissioning 14**
- User Instructions 16**
 - Clock Setting 20
- Fault Diagnosis 22**
 - Heater Settings 22
- Maintenance 26**
 - Handset - Cleaning 26
 - Inlet Filter - Cleaning/Renewing 26
 - Clock Battery Replacement Procedure 27
- Spare Parts 28**
 - Mira Orbis 28
- Accessories 28**
- Dimensions 30**
- Wiring Diagram 30**
- Customer Services 31**

Patents and Design Registration

Design Registration	000738141-0002
Patents	GB: 2 341 667 Eire: 82835
Patent Applications	UK: 2 428 286, 2 427 460 Eire: 2004/0483, 2006/0462

Introduction

Thank you for purchasing a quality Mira product. To enjoy the full potential of your new product, please take time to read this guide thoroughly. Having done so, keep it handy for future reference.

The Mira Orbis is a thermostatic electric shower with separate controls for power selection and temperature/flow adjustment. A unique thermostatic valve stabilises temperature changes caused by water pressure fluctuations. These can result from taps being turned on or off, or toilets being flushed. A digital display indicates shower temperature, clock (with battery backup), low flow and over temperature warnings. The Mira Orbis comes complete with a set of Mira Energise Shower Fittings.

Mira Orbis 9.0 kW

A 9.0 kW 240 V AC (8.2 kW 230 V AC) heater with Mira Energise adjustable spray handset with four different spray actions (start, soothe, force and eco*). Supplied complete with flexible hose, clamp bracket assembly, slide bar, supports, hose retaining ring and soap dish. Available in white/chrome.

Mira Orbis 9.8 kW

A 9.8 kW 240 V AC (9.0 kW 230 V AC) heater with Mira Energise adjustable spray handset with four different spray actions (start, soothe, force and eco*). Supplied complete with flexible hose, clamp bracket assembly, slide bar, supports, hose retaining ring and soap dish. Available in white/chrome and black/chrome finish.

Mira Orbis 10.8 kW

A 10.8 kW 240 V AC (9.9 kW 230 V AC) heater with Mira Energise adjustable spray handset with four different spray actions (start, soothe, force and eco*). Supplied complete with flexible hose, clamp bracket assembly, slide bar, supports, hose retaining ring and soap dish. Available in white/chrome finish.

* The eco setting reduces the water flow to give economical use of water, whilst still giving an adequate shower performance. This setting performs best with most gravity, pumped, and mains pressure unvented systems. On electric showers and some combination boiler systems the economy setting will have no effect, and will give the same spray action as the start setting.

If you experience any difficulty with the installation or operation of your new Electric Shower, please refer to 'Fault Diagnosis', before contacting Kohler Mira Ltd. Our telephone and fax numbers can be found on the back cover of this guide.

Important Safety Information

Installation must be carried out in accordance with these instructions, and must be conducted by designated, qualified and competent personnel.

Warning!

Follow all warnings, cautions and instructions contained in this guide, and on or inside the appliance.

1. Products manufactured by us are safe and risk-free, provided that they are installed, used and maintained in good working order, in accordance with our instructions and recommendations.
2. Isolate the electrical and water supplies before commencing installation. The electricity must be turned off at the mains and the appropriate circuit fuse removed, if applicable.
3. Mains connections are exposed when the cover is removed.
4. Refer to the wiring diagram before making any electrical connections (refer to the wiring diagram at the back of this guide).
5. Make sure that any pipework that could become frozen is properly insulated.
6. Having completed the installation, make sure that the user is familiar with the operation of the appliance.
7. Make sure that this guide is left with the user.
8. **DO NOT** commission this appliance if water leaks from the unit or the heater tank pressure relief valve.
9. **DO NOT** fit any form of outlet control (e.g. Trigger handset) as the outlet acts as a vent for the tank body. Only Mira recommended outlet fittings should be used.
10. Make sure all electrical connections are tight, to prevent overheating.
11. The shower unit must not be fitted where it may be exposed to freezing conditions. Make sure that any pipework that could become frozen is properly insulated. If the appliance appears to be frozen, allow to thaw and then contact your installer before using again.
12. This product is not suitable for areas with high humidity (i.e steam rooms). Please consult your installer.
13. **THIS APPLIANCE MUST BE EARTHED. MAKE SURE SUPPLEMENTARY BONDING COMPLIES WITH THE “REQUIREMENTS FOR ELECTRICAL INSTALLATIONS”.**

The installation must be in accordance with the current edition of 'The Plugs and Sockets etc. (Safety) Regulations' in force at the time of installation, this Mira Orbis is intended to be permanently connected to the fixed electrical wiring of the mains system.

Caution!

1. Read all of these instructions and retain this guide for later use.
2. The electrical installation must comply to “BS 7671 - Requirements for Electrical Installations”, commonly referred to as the IEE Wiring Regulations - Part 7, or any particular regulations and practices, specified by the local electricity supply company.
3. The plumbing installation must comply with the requirements of UK Water Regulations/Bye-laws (Scotland), Building Regulations or any particular regulations and practices, specified by the local water company or water undertakers.
4. Make sure that you fully understand how to operate this shower and make sure that it is properly maintained in accordance with the instructions given in this manual.
5. Anyone who may have difficulty understanding or operating the controls of any shower should be attended whilst showering. Particular consideration should be given to:
 - 5.1. The young.
 - 5.2. The elderly.
 - 5.3. The infirm.
 - 5.4. The disabled.
 - 5.5. Anyone who suffers from a medical condition that can result in temporary incapacity (e.g. epilepsy or blackouts).
 - 5.6. Anyone inexperienced in the correct operation of the controls.
6. Sunburn or skin conditions can increase your sensitivity to hot water. Make sure that you set the shower to a cooler temperature.
7. If any of the following conditions occur, isolate the electricity and water supplies and refer to “To contact us”, on the back page of this guide:
 - 7.1. If the cover is not correctly fitted and water has entered the appliance case.
 - 7.2. If the case is damaged.
 - 7.3. If the appliance begins to make an odd noise, smell or smoke.
 - 7.4. If the appliance shows signs of a distinct change in performance, indicating a need for maintenance.
 - 7.5 **DO NOT** operate this appliance if water leaks from this appliance.
8. When this appliance has reached the end of its serviceable life, it should be disposed of in a safe manner, in accordance with current local authority recycling, or waste disposal policy.

Pack Contents Checklist

Tick the appropriate boxes to familiarise yourself with the part names and to confirm that the parts are included.

Mira Orbis



1 x Mira Orbis

1 x Olive

1 x Compression Nut

3 x Fixing Screws

3 x Wall Plugs

2 x Case Inserts

Documentation

1 x Guarantee Registration Document

1 x Installation Template

1 x Installer Checklist

Specifications

1. Plumbing

- Minimum maintained inlet pressure for 9.0 kW and 9.8 kW, 70 kPa (0.7 bar) for satisfactory operation.
- Minimum maintained inlet pressure for 10.8 kW, 100 kPa (1.0 bar) for satisfactory operation.
- Maximum static inlet pressure 1000 kPa (10 bar).
- Minimum static pressure 20 kPa (0.2 bar) to keep the inlet valve closed.

2. Electrical

- The Mira Orbis 9.0 kW requires a 40 Amp circuit protection device.
- The Mira Orbis 9.8 kW requires a 45 Amp circuit protection device.
- The Mira Orbis 10.8 kW requires a 45 Amp circuit protection device.
- The terminal block will accept cable up to 16 mm².

3. Standards and Approvals

- The Mira Orbis complies with all relevant directives for CE marking.

Installation Requirements

1. Plumbing

- The appliance is designed to operate with a minimum maintained inlet pressure of 0.7 bar (for 9.0 kW and 9.8 kW) and 1.0 bar (for 10.8 kW) up to a maximum static inlet pressure of 10 bar.
- When installed in very hard water areas (above 200 ppm temporary hardness) your installer may advise the installation of a water treatment device, to reduce the effects of limescale formation. Your local water company will be able to advise the hardness of water in your area.
- It is recommended that a non-restrictive (free flowing) isolating valve is fitted in the cold water supply pipe to allow the complete maintenance of the appliance. Do not use a valve with a loose washer plate (jumper) as this can lead to a build up of static pressures.
- The appliance is suitable for installation within the shower area. It is fitted with a pressure relief device and must be positioned over a water catchment area with the controls at a convenient height for all users.
- The appliance must be fitted on to a finished flat and even wall surface (this wall surface should be tiled or waterproofed). **DO NOT** fit the appliance to the wall and tile up to the case. For safety requirements, an air gap must be left behind the appliance.

- Avoid layouts where the shower hose will be sharply kinked. This may reduce the life of the hose.
- A Soap Dish/Hose Retaining Ring is supplied to prevent the handset from dropping below the spill-over level of the bath or shower tray, which could lead to contamination from back-siphoning. The supplied Hose Retaining Ring should meet the majority of user requirements for shower installations with flexible outlet fittings. However, there will be occasions when it will not provide a suitable solution. In these instances an outlet double checkvalve, e.g. a Mira DCV-H, must be fitted. This will increase the required supply pressure typically by 0.1 bar (see section “Accessories”).
- Supply pipework **MUST** be flushed to clear debris before connecting to the appliance.
- To avoid damage to the case when soldered fittings are used, pre-solder the pipework and fittings before connecting them to the inlet connector assembly. Refrain from applying excessive force when making any connections. Always provide mechanical support when making the plumbing connections.
- The appliance is fitted with a brass inlet compression assembly for connecting to a 15 mm supply pipe from the top, bottom or back. The fitting of double checkvalves in the inlet supply to the appliance, can cause a pressure build-up, which could exceed the maximum static inlet pressure and damage the appliance.

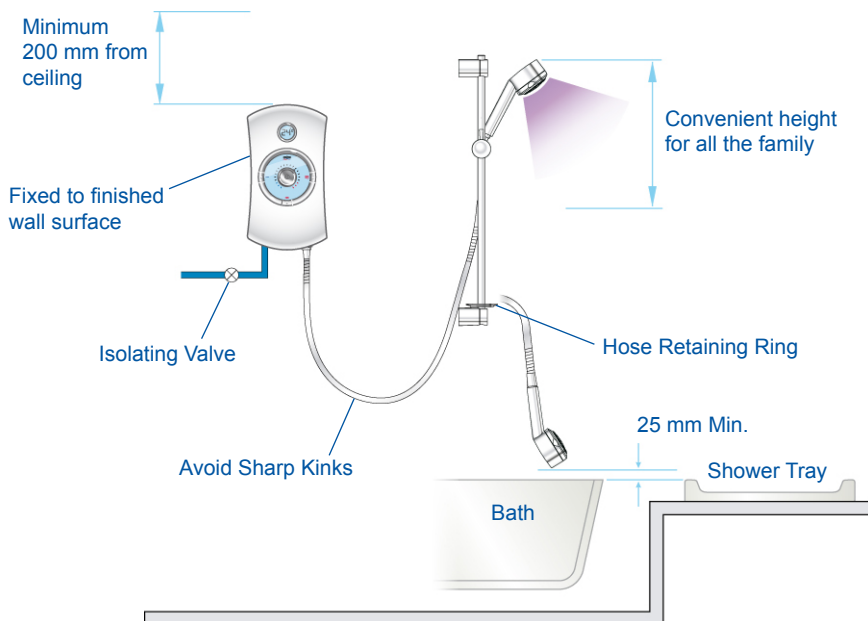

2. Electrical

- In a domestic installation, the rating of the electricity supplier's fuse and the consumer unit must be adequate for the additional demand. All Mira electric showers are high power units, it is essential to contact your electricity supplier to ensure that the supply is adequate for the product. Voltage drop due to local heavy demand will reduce the shower's performance.
- The appliance **must be earthed** by connecting the supply-cable earth conductor to the earth terminal. Supplementary bonding: Within the bathroom or shower room, all accessible conductive parts of electrical equipment and extraneous conductive parts (metal parts) that are likely to introduce earth potential, must be electrically bonded to earth using a minimum cable size of 4.0 mm² if the cable is not mechanically protected, (2.5 mm² if mechanically protected).
- The minimum cable size (cross-sectional area) required should be in accordance with BS 7671.
- As a guide only, and in accordance with BS 7671 we recommend close circuit protection: i.e. 9.8 kW = 45 Amp
- It is strongly recommended that a 30mA Residual Current Device (RCD) is included in the electrical circuit. This may be part of the consumer unit or a separate unit.
- A separate, permanently connected supply must be taken from the consumer unit to the appliance through a double-pole switch, which has at least 3 mm contact separation. The switch can be a ceiling mounted pullcord type within the shower room or a wall mounted switch in an adjacent room.
- **DO NOT** twist the individual cable cores of either the live or neutral conductors, as this will prevent them from entering the terminal block.
- **DO NOT** exert strain on the terminal block. Make sure that the electrical connections are tightly screwed down.
- **DO NOT** turn-on the electrical supply until the plumbing has been completed.

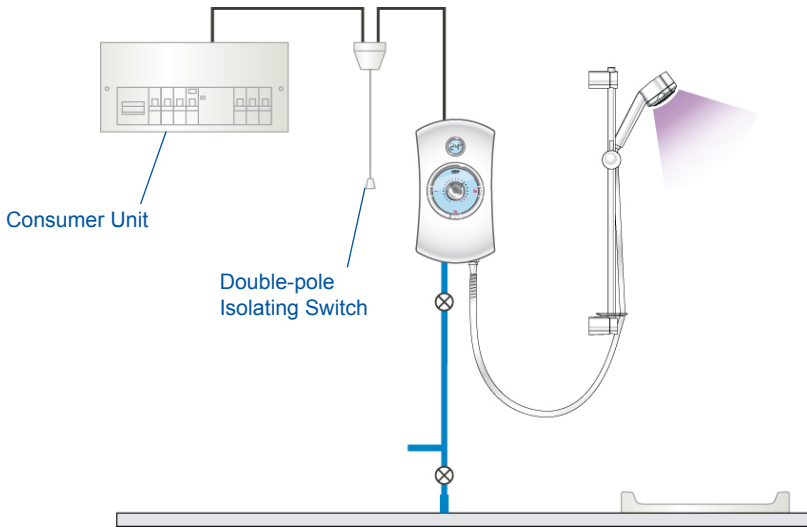

Installation

Installation of Mira Orbis

► **Warning!** Turn off the electrical and water supplies before proceeding with the installation of the Mira Orbis. The electricity must be turned off at the mains and the appropriate circuit fuse removed, if applicable.

► **Note!** An installation template is supplied to help you install the Mira Orbis.

► Remove the three cover retaining screws.

► Carefully remove the cover, making sure that you do not strain the multi-connector.

► Carefully remove the multi-connector from the socket on the control PCB in the case

► Remove the service tunnel.

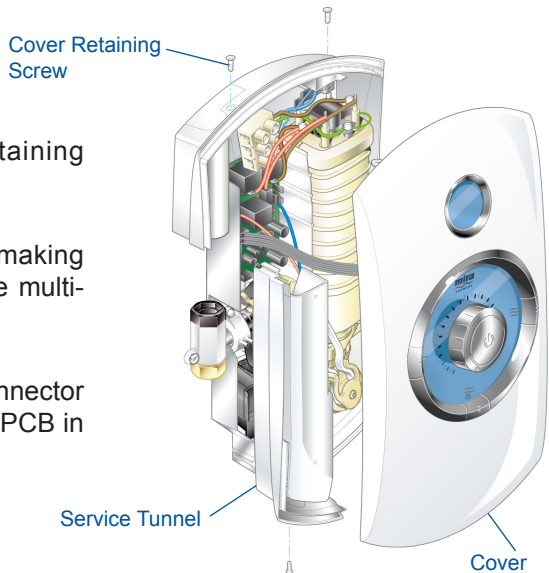

▶ Determine the direction of the inlet water supply: top (falling), bottom (rising), or back inlet.

▶ **Note!** Make sure that the back inlet does not go directly back into the wall. Use a soldered elbow.

▶ Swivel the inlet connector assembly to suit. Remove the inlet blanking cap. Avoid trapping the green earth bonding wire.

▶ Two case inserts are supplied with the Mira Orbis, so that they can be trimmed to suit the supplies entering the product. Before fitting the cover, make sure that the case inserts are fitted.

▶ **Thoroughly flush the mains-fed cold water supply pipe. The supply must be clean and free from debris BEFORE connecting the Mira Orbis.**

To flush the pipework, turn on the water supply and drain a minimum of 10 litres (2 gallons) of water into a bucket or catchment area. Turn off the water supply.

▶ An installation template is supplied to help you install the Mira Orbis. Put the installation template on the wall and mark through the positions of the fixing holes. Make sure that the position of these holes do not come in line with any buried cables or pipework. Make sure that sufficient electrical supply cable is available for connection to the terminal block.

▶ Drill and plug the top two fixing holes. Secure the Mira Orbis to the wall with the screws provided. Drill the bottom fixing hole with the product in place. Alternative fixings (not supplied) may be necessary for some wall structures. Avoid drilling into any supply cable/pipe.

▶ Install the mains-fed cold water supply pipe. Do not overtighten.

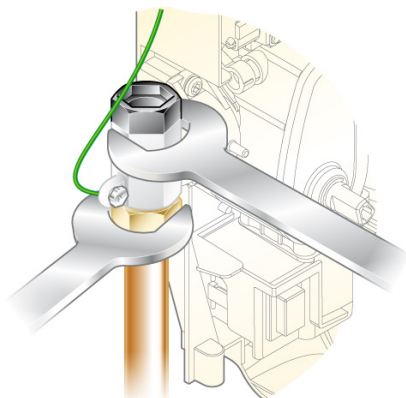
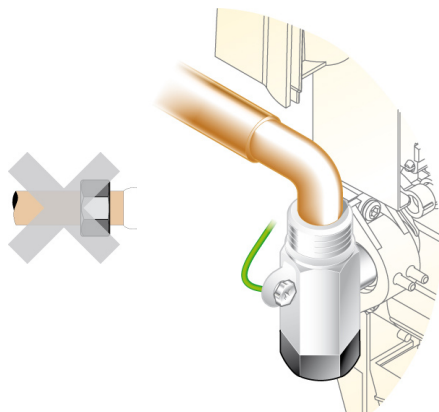

- ▶ Feed cable into Case. Fit Earth sleeve (not supplied) and strip insulation. Do not twist cable cores.

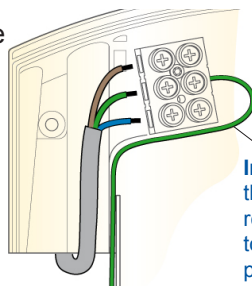

Important! Make sure that the inlet earth wire is routed as shown. Failure to do so may cause product malfunction.

- ▶ Firmly connect the conductors to the multi-connector. Do not exert strain on the terminals.

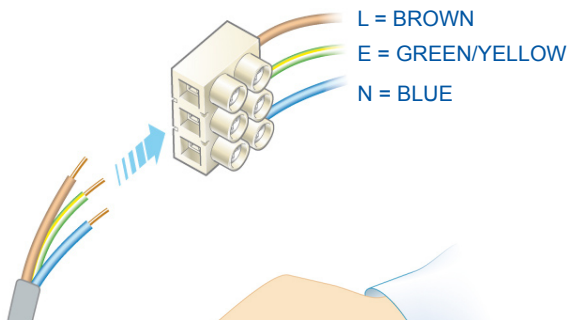

- ▶ Before refitting the cover, pull the plastic tab off the battery to activate it.

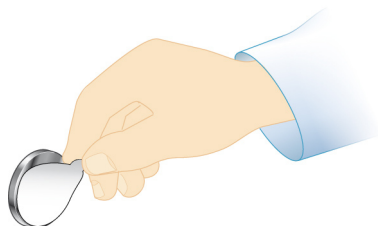

- ▶ Refit the Service Tunnel.
- ▶ Connect the multi-connector to the socket on the PCB.
- ▶ Refit the Cover. Make sure that it fits correctly. Do not overtighten screws.
- ▶ Do not use alternative screws to secure the Cover. This can cause internal damage to the appliance. Do not seal around the back of appliance.
- ▶ Install the shower fittings in accordance with the manufacturer's instructions.

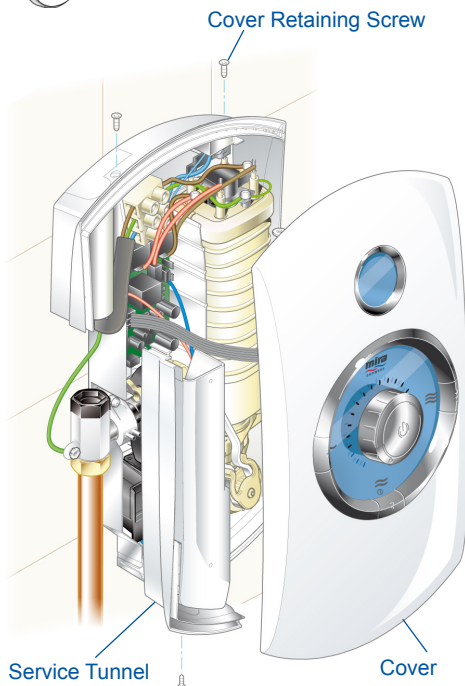

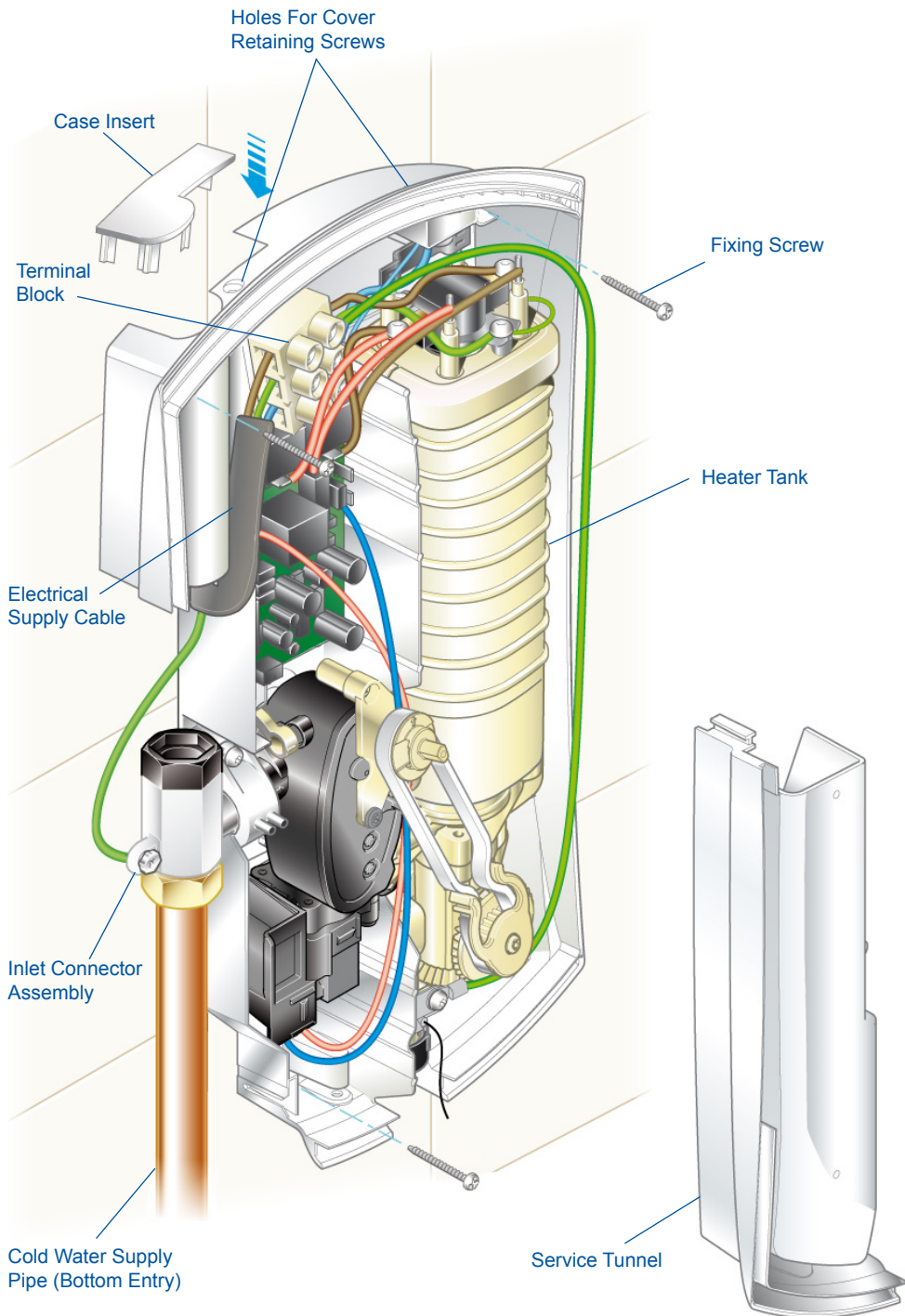

Commissioning

If you are unsure how an electric shower works, please read through the **User Instructions** section before continuing.

Note! The temperature display throughout this guide will depend upon inlet supply conditions and product settings.

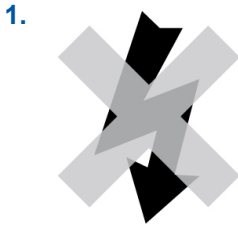

Electrical supply is turned off at the mains.



Turn control to full cold.

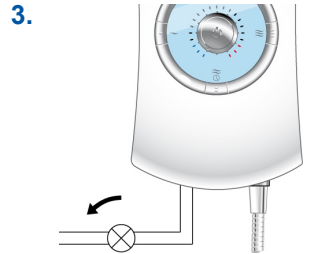

Turn the water supply fully on.



Check for water leaks.

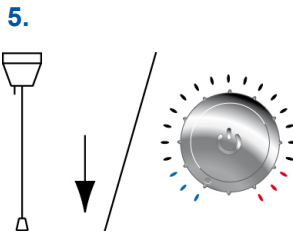

Switch on the electrical supply and press the 'Start/Stop' button

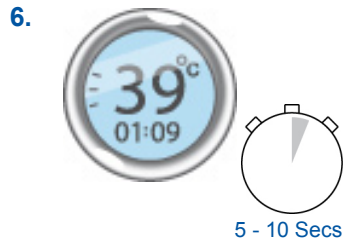

The temperature indicator becomes illuminated, showing time. Temperature will be displayed after a few seconds.

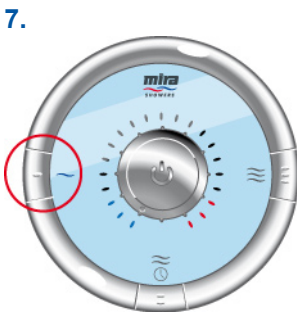

Press the 'Low' button, light on the button comes on

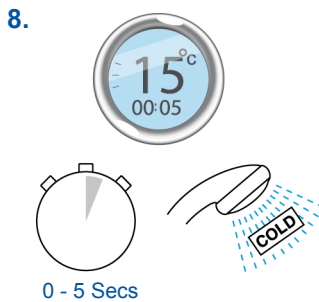

Water will be at full force and at a cool temperature as indicated by the temperature indicator.



Turn the control slowly. Temperature remains cool and flow is reduced



Turn control to full cold.

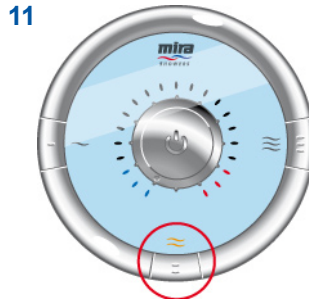

Press the 'Medium' button, light on the button comes on

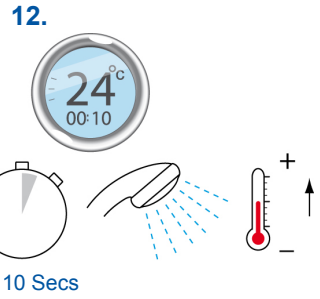

The temperature will rise slightly as indicated by the temperature indicator.



Press the 'High' button, light on the button comes on

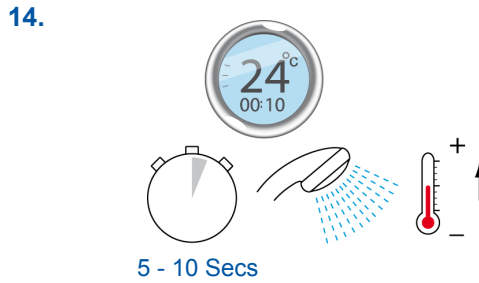

The flow rate will increase.



Adjust temperature as required. Flow rate will adjust automatically.

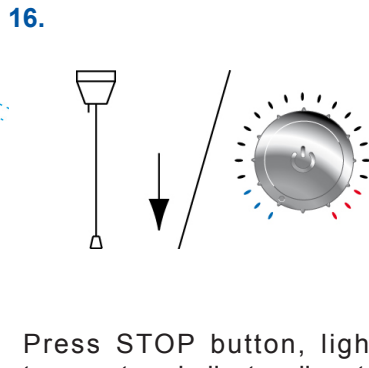

Press STOP button, light on the temperature indicator dims to standby state. When the shower has stopped running the temperature display will only show the clock. The water flow will continue for a few seconds before stopping. Isolate power. Display will go blank.

17.

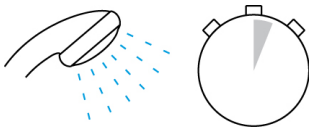

0 - 5 Secs

The shower will purge water from its tank for a few seconds.

18.



Residual water may drain over a few minutes.

Note! A slight hissing sound may be heard from the Mira Orbis during operation. High mains water pressure and high shower temperatures will affect the tone. This is quite normal in use.

User Instructions

How Your Electric Shower Works

Heated water is produced by adjusting the flow of cold water passed through a heater tank.

The temperature indicator shows the temperature of the shower.

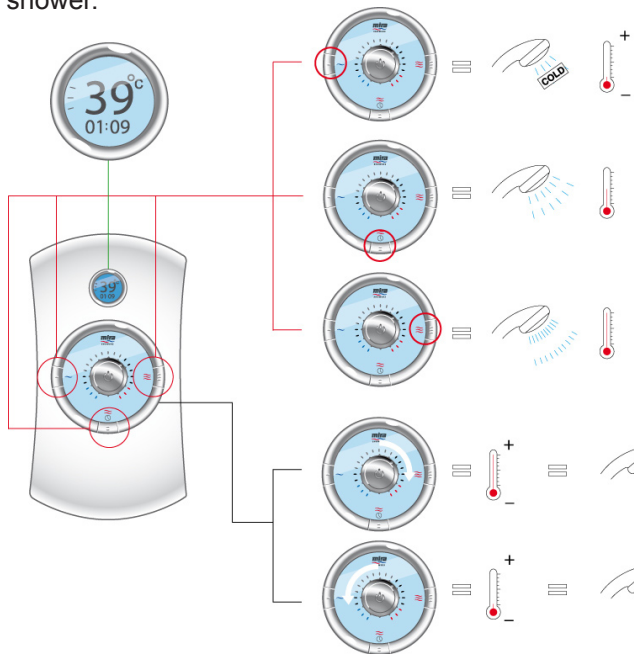

The shower has three heater settings.

The warmer the shower, the lower the flow rate and vice versa.

The Effect of Seasonal Changes

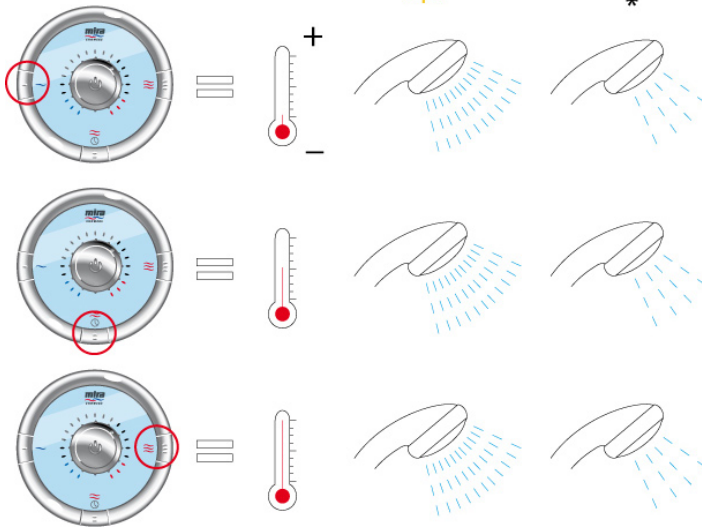

For a cold shower select 'Low'.

For a summer warm shower select 'Medium'.

For a winter warm shower select 'High'.

During extremes of mains water supply temperature, adjust heater setting to obtain a better showering temperature.

The Effect of Other Water Devices

Example of how shower temperature stabilises due to pressure changes.

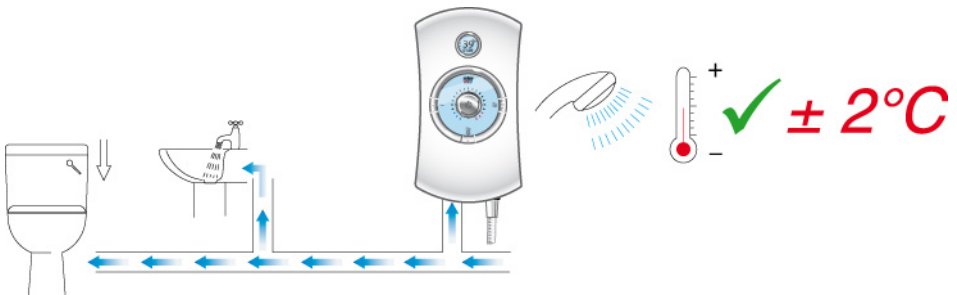

Water inlet pressure fluctuations due to other draw offs (e.g. flushing toilet). Shower temperature will be controlled to within $\pm 2^{\circ}\text{C}$ of the set temperature provided that the supply conditions remain within the required operating parameters (refer to section: '**Specifications**').

Using your Shower

Read the section “Important Safety Information” first.

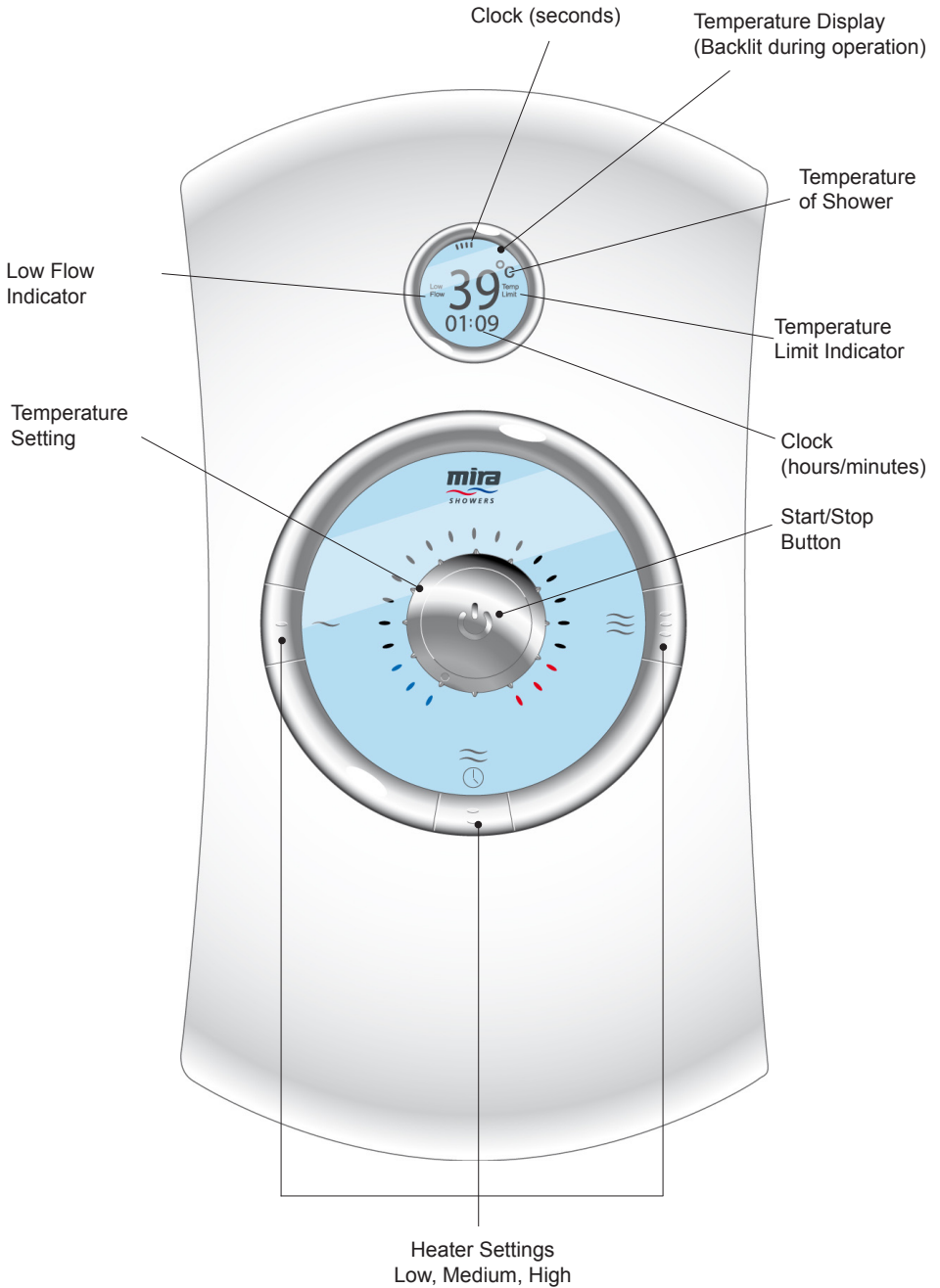

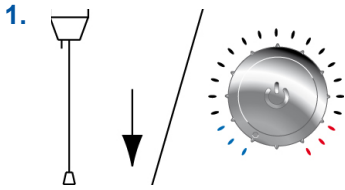

Switch on the electrical supply and press the 'Start/Stop' button

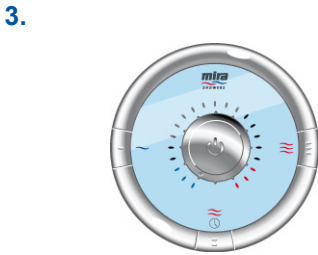

Set to desired position.

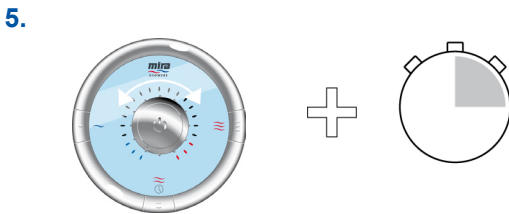

Allow 10 - 15 seconds for any temperature adjustments to reach the handset.

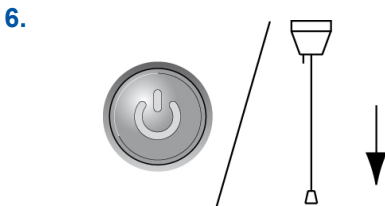

Press STOP button, light on the button goes out. Shower flow will continue for a few seconds before stopping. Switch off the electrical supply.

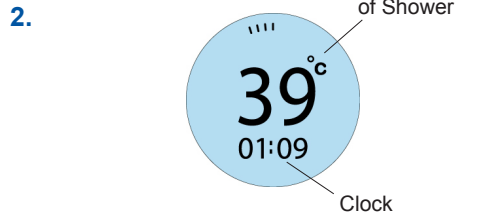

The temperature indicator becomes illuminated.

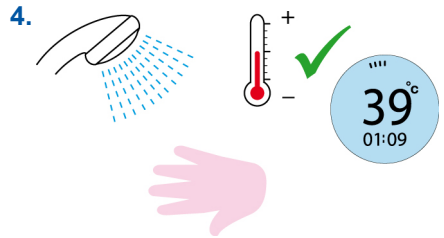

Check water temperature before entering shower.



Residual water may drain over a few minutes.

Note! At the end of every shower make sure that the shower head points into the catchment area. A small amount of water may be retained in the shower handset after the shower has been turned off. This may drain over a few minutes.

Clock Setting



1. Make sure that the product is in 'Standby' state (i.e. Isolator switch on).
2. Press and hold the 'Medium Power' button - the clock backlight will come on full brightness.
3. After a delay of a few seconds the hour segments of the clock start flashing
4. Press 'Medium Power' button repeatedly until desired 'hours' are displayed on the clock.
5. After a short delay of a few seconds the minute segments of the clock start flashing.
6. Press 'Medium Power' button repeatedly until desired 'minutes' are displayed on the clock.
7. After a short delay of a few seconds the minutes segments stop flashing and the clock backlight dims to its standby state.

LCD Indications

The table below shows what is shown on the LCD display once the shower has been installed and is in use.

Product State	LCD Display	Backlight	Comments
Off	Blank	Off	Product turned off at pull cord
Standby	Clock shown including second indicators	Dim	
Product turned on via Start/Stop button	Clock Shown including second indicators Will display temperature after a few seconds	Full Brightness	On initial start up unit will turn onto low power. The next time you turn the unit on it will be at the previous setting
Switching Power	Clock shown including second indicators Will display temperature after a few seconds	Full Brightness	Flow will change accordingly
Product turned off via - on/off button	Clock shown including second indicators	Fade to Dim	
Low Flow	Clock shown including second indicators Low Flow graphic displayed	Backlight flashes	Product will stop heating the water, flow will reduce.
Temp Limit	Clock shown including second graphics Temp Limit graphic displayed	Backlight flashes	Product will stop heating for 10 seconds and then restart. - turn the temperature control down.

Fault Diagnosis

The trouble shooting information tabled below gives details on probable causes and remedies should difficulties be encountered whilst the shower is in operation.

Warning! There are no user serviceable components beneath the cover of the appliance. **Only a competent tradesperson should remove the front cover!**

Heater Settings

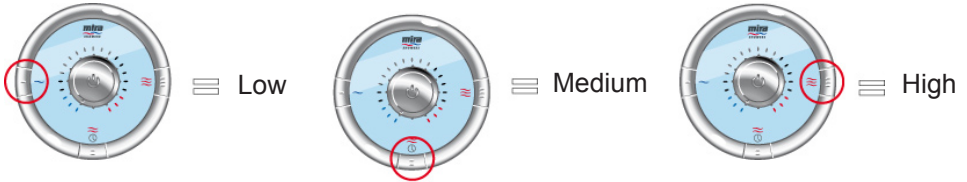

Symptom	LCD Back Light	Low Flow Warning	Heater Setting Low/Medium/ High	Probable Cause	Probable Remedy
Appliance fails to operate	OFF	OFF		Electrical supply isolated at double pole switch.	Switch on electrical supply via the pullcord or wall mounted switch.
	OFF	OFF		Fuse blown or MCB/RCD tripped, indicating possible electrical fault.	Renew the fuse or reset the MCB/RCD. If fault persists, contact your installer.
	OFF	OFF		Faulty Relay PCB.	Replace Relay PCB.
	OFF	OFF		Faulty Control PCB.	Replace Control PCB.
Shower cycles from hot to cold	ON	ON	Medium/High	Handset blocked.	Remove and clean.
	ON	ON	Medium/High	Inlet Filter blocked.	Remove and clean.
	ON	ON	Medium/High	Water pressure below minimum required for the appliance to operate.	Make sure incoming mains water stopcock and/or appliance isolating valve is fully turned on.
	ON	ON		Faulty Relay PCB.	Replace Relay PCB.
	ON	ON		Faulty Solenoid.	Replace Inlet Valve Assembly.
	ON	OFF	High	Temperature limit reached (flashes on LCD).	Turn the temperature control down or reduce heater setting to Medium until a cooler temperature is achieved.

Symptom	LCD Back Light	Low Flow Light	Heater Setting Low/Medium/High	Probable Cause	Probable Remedy
Shower cycles from hot to cold	ON	OFF	Medium/High	Thermostatic mechanism is faulty or damaged.	Replace.
	ON	OFF	Medium/High	Scaled Heater Tank Assy.	Replace.
	ON	OFF	Medium/High	Damaged Hose.	Replace.
Handset dripping	OFF	OFF		Insufficient water supply pressure for shut off.	The minimum static pressure to ensure shut off and prevent dripping is 0.2 bar. Note! If other appliances are operating, static pressure may drop below 0.2 bar. Contact local water company.
	OFF	OFF		Inlet valve assembly faulty.	Replace.
Low or no flow rate	ON	ON	Any	Water supply pipework or inlet filter restricted by a blockage or partial blockage.	Flush supply pipe. Clean inlet filter.
	OFF	OFF		Insufficient water supply pressure/ flow for operation.	Contact local water company. Supply pressure must be a minimum of 100 kPa (1.0 bar). Note! If other appliances are operating, pressure may drop below 100 kPa (1.0 bar).
	OFF	OFF		Faulty Relay PCB.	Replace Relay PCB.
	OFF	OFF		Faulty Control PCB.	Replace Control PCB.
	ON	ON	Any	Other outlets (e.g. toilet, garden hose, washing machine etc.) drawing water whilst the shower is being used.	Turn off the other appliances whilst the shower is in use.
	ON	OFF	Any	Hose Damaged.	Replace.

Symptom	LCD Back Light	Low Flow Light	Heater Setting Low/Medium/High	Probable Cause	Probable Remedy
Low or no flow rate	ON	OFF	Any	Handset blocked.	Remove and clean.
	ON	OFF	Any	Heater tank excessively scaled.	Replace. In hard water areas consider the use of a water softener.
No information shown on LCD display	ON	OFF	Any	Faulty Control PCB.	Replace Control PCB.
Operation of temperature control has little or no effect on water temperature.	ON	ON	Medium/High	Handset or inlet filter blocked.	Remove and clean.
	ON	OFF	Medium/High	Thermostatic valve faulty.	Replace.
	ON	OFF	Medium/High	Heater tank failure.	Replace.
	OFF	OFF		Relay PCB failure.	Replace Relay PCB assembly.
No change in temperature between Low/Medium/High setting.	ON	ON	Any	Insufficient mains water pressure.	Contact local water company.
	ON	OFF	Any	Possible failure of thermostatic valve or heater tank.	Check the continuity of the heater tank and replace parts as necessary.
	OFF	OFF		Control PCB failure.	Replace Control PCB assembly.
	OFF	OFF		Thermal Trip failed.	Replace thermal trip or check the continuity of the heater tank and replace parts as necessary.
Water will not turn off.	ON	OFF	Any	Inlet valve, solenoid, stop switch, relay PCB or Control PCB faulty.	Replace as necessary.
	ON	ON	Any	Supply pressure below 20 kPa (0.2 bar).	Contact local water company. Check mains water static pressure.

Symptom	LCD Back Light	Low Flow Light	Heater Setting Low/Medium/ High	Probable Cause	Probable Remedy
Appliance fails to produce hot water when set on 'Medium/High' heater setting.	ON	ON	Medium/High	Insufficient water supply.	Contact local Water company.
	ON	OFF	Medium/High	Possible failure of the thermal switch.	Check the continuity of the heater tank and replace parts as necessary.
	ON	OFF	Medium/High	Heater tank failure.	Replace.
Unable to select a cool enough shower.	ON	OFF	High	Due to the rise in mains water supply temperature, the heater setting may be too high.	Press the 'Medium' heater setting and adjust the temperature control until a suitable temperature is reached.
Clock does not keep time	ON	OFF	Any	Battery needs replacing.	Replace battery.
				Faulty Control board.	Replace.
E1 displayed on screen	ON	OFF	Any	Check thermistor is plugged in.	Refit.

Maintenance

Handset - Cleaning

- ▶ Clean with mild washing up detergent or soap solution. Wipe dry with a soft cloth.
- ▶ Poor shower performance can be avoided by cleaning the spray plate. Use thumb or soft cloth to wipe rubber nozzles. The handset must also be descaled regularly.

Inlet Filter - Cleaning/Renewing

Read the section “Important Safety Information” first

- ▶ Make sure that the electrical supply is turned off at the mains and that the water supply is fully turned off.
- ▶ Remove the three screws. Carefully remove the cover, making sure that you do not strain the multi-connector.
- ▶ Carefully remove the multi-connector from the socket on the control PCB in the case. Remove the service tunnel.
- ▶ Hold a wrench across the flats of the metal connector. Unscrew the filter using another wrench as shown. Clean or renew the Filter as necessary. Refit in reverse order making sure the Filter is screwed fully home.
- ▶ Do not overtighten. Make sure plumbing connections are tight before restoring the electricity and water supply. Check for leaks.
- ▶ Refit the Service Tunnel and connect the multi-connector to the socket on the PCB.
- ▶ Refit the Cover. Make sure that it fits correctly. Do not overtighten screws.

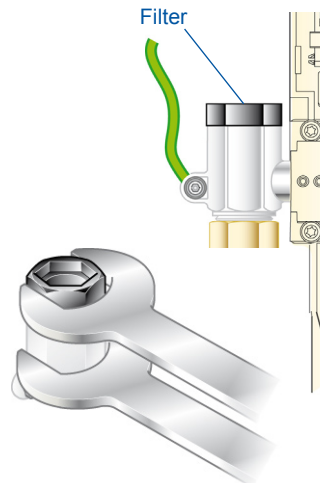
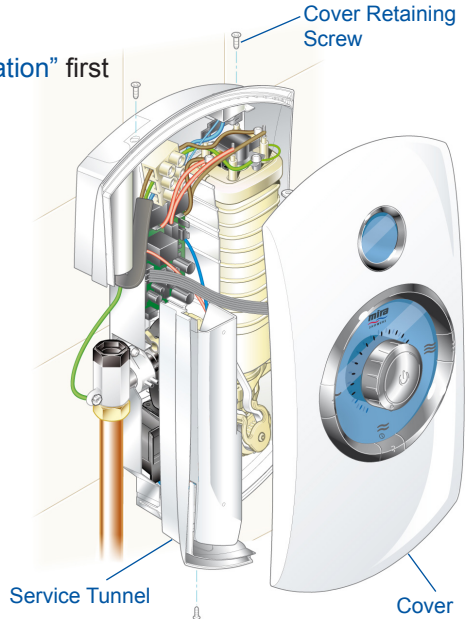

Clock Battery Replacement Procedure

Warning! There are no user serviceable components beneath the cover of the appliance. **Only a competent tradesperson should remove the front cover!**

Read the section “Important Safety Information” first.

1. Isolate the electrical supply before commencing this procedure. The electricity must be turned off at the mains and the appropriate circuit fuse removed, if applicable.
2. Mains connections are exposed when the cover is removed.

▶ Remove the three screws. Carefully remove the cover, making sure that you do not strain the multi-connector.

▶ Carefully remove the multi-connector from the socket on the control PCB in the case. Remove the service tunnel.

▶ Carefully remove the battery from the housing.

▶ **When the battery has reached the end of its serviceable life, make sure the battery is disposed of in a safe manner, in accordance with current local authority recycling, or waste disposal policy.**

▶ Refit a new battery.
(Battery type BR 2032 or CR2032)

▶ Connect the multi-connector to the socket on the PCB.

▶ Refit the Cover. Make sure that it fits correctly. Do not overtighten the three cover retaining screws.

Restore the electrical supply.

▶ Reset the clock, refer to the ‘Clock Setting’ procedure.

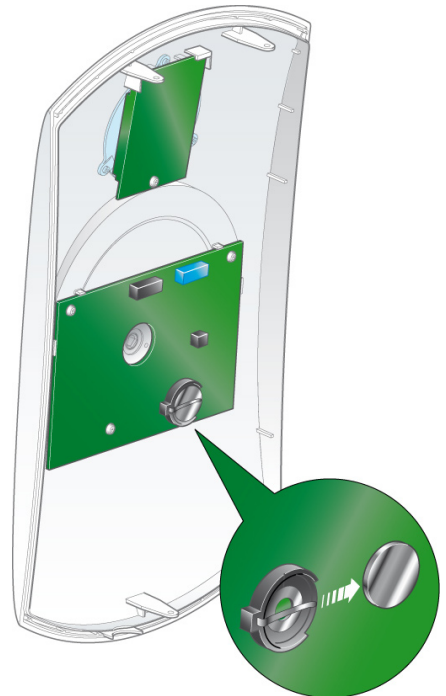

Spare Parts

Mira Orbis

405.58	Inlet Connector Assembly
406.27	Inlet Filter (with 'O' seal fitted)
416.38	Clamp Bracket (Inlet)
416.51	Solenoid Coil
1563.518	Component Pack - components identified 'B'
1563.522	Cover Seal (not shown)
1563.541	Screw Pack - components identified 'A'
1647.095	Thermal Switch (one shot)
1647.096	Terminal Block Assembly
1647.098	Thermostatic Valve/Heater Tank 9.0 kW 240 V AC
1647.099	Thermostatic Valve/Heater Tank 9.8 kW 240 V AC
1647.100	Thermostatic Valve/Heater Tank 10.8 kW 240 V AC
1647.101	Outlet Connector Assembly
1647.102	Temperature Control Belt
1647.103	Inlet Valve Assembly
1647.104	Cover Assembly
1647.105	Relay PCB
1647.106	Control PCB
1647.107	LCD Display
1647.108	Thermistor
1647.109	Service Tunnel and Insert
1647.110	Wire Pack
1647.148	Cover Assembly (black)
1647.149	LCD Display (black)
1647.150	Service Tunnel and Insert (black)

Accessories

DCV-H: An outlet double check valve, designed to prevent the backflow or backsiphonage of potentially contaminated water, through shower controls which are fitted with a flexible hose as part of the outlet shower fitting. Available as an optional accessory from your Mira Showers stockists.



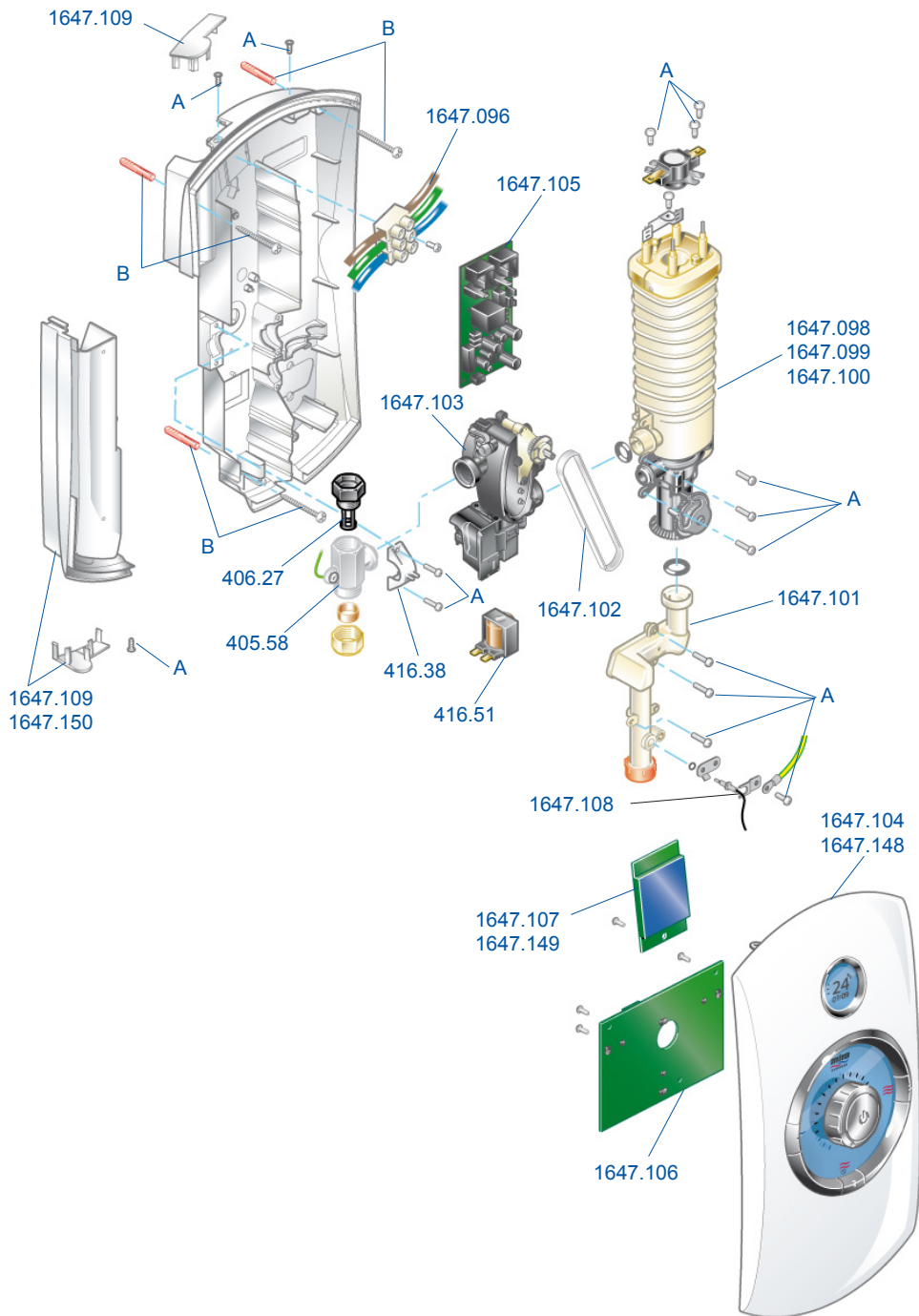

Dimensions

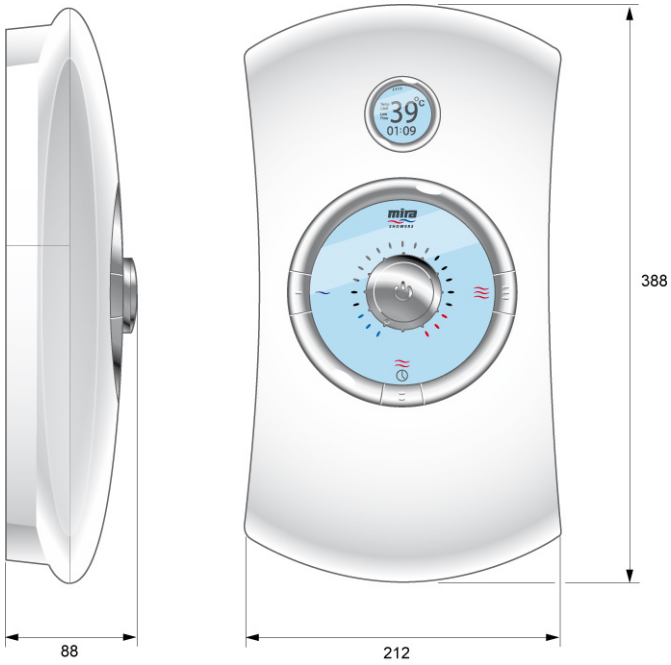

Wiring Diagram

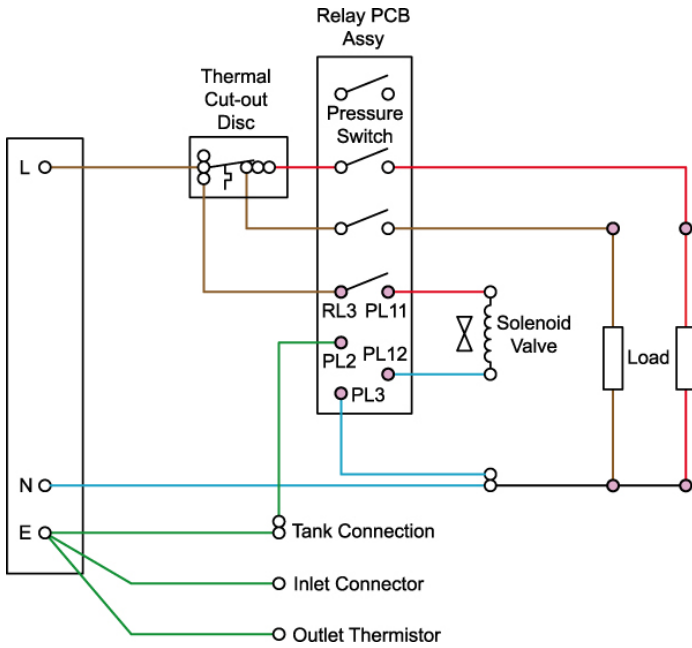

Customer Services

Guarantee of Quality

Mira Showers guarantee your product against any defect in materials or workmanship for the period shown in the Guarantee Registration Document included with your shower.

Alternatively, to confirm the applicable guarantee period please contact Customer Services.

To validate the guarantee, please return your completed registration card.

Within the guarantee period we will resolve defects, free of charge, by repairing or replacing parts or modules as we may choose.

To be free of charge, service work must only be undertaken by Mira Showers or our Approved Agents.

Service under this guarantee does not affect the expiry date.

The guarantee on any exchanged parts or product, ends when the normal product guarantee period expires.

Not covered by this guarantee

Damage or defects arising from incorrect installation, improper use or lack of maintenance, including build-up of limescale.

Damage or defects if the product is taken apart, repaired or modified by any person not authorised by Mira Showers or our Approved Agents.

This guarantee is in addition to your statutory and other legal rights.

Before using your shower

Please take the time to read and understand the operating and safety instructions detailed in this manual.

What to do if something goes wrong

If when you first use your shower and it doesn't function correctly, first contact your installer to check that the installation and commissioning are satisfactory and in accordance with the instructions in this manual.

Should this not resolve the difficulty, simply contact our Customer Services who will give every assistance, and if necessary arrange for our Service Engineer to visit.

If later the performance of your shower declines, consult this manual to see whether simple home maintenance is required.

Please call our Customer Services to talk the difficulty through, request service under guarantee if applicable, or take advantage of our comprehensive After-Sales Service.

As part of our quality and training programme calls may be recorded or monitored.

Our Customer Services Team is comprehensively trained to provide every assistance you may need: help and advice, spare parts or a service visit.

Spare Parts

We maintain an extensive stock of spares, and aim to provide support throughout the product's expected life.

Spares can be purchased from approved stockists or merchants (locations on request) or direct from Customer Services.

Spares direct will normally be despatched within two working days. Payment can be made by Visa or Mastercard at the time of ordering. Should payment by cheque be preferred a pro-forma invoice will be sent.

All spares are guaranteed for 12 months from the date of purchase. spares that have been supplied directly from us can be returned within one month from the date of purchase providing that they are in good order and the packaging unopened.

Note! Returned spares will be subject to a 15% restocking charge and authorisation must be obtained before return, contact our Customer Services Team.

Note! In the interests of safety, spares requiring exposure to mains voltages can only be sent to competent persons.

Service

Our Service Force is available to provide a quality service at a reasonable cost. You will have the assurance of a Mira trained Engineer/Agent, genuine Mira spares and a 12 month guarantee on the repair.

Payment should be made directly to the Service Engineer/Agent, using Visa, MasterCard or a cheque supported by a banker's card.

To contact us

England, Scotland, Wales and Northern Ireland
Mira Showers Customer Services

Telephone: 0870 241 0888
Mon. to Fri. 8:00 am to 5:30 pm
8:30 am to 3:30 pm Saturday
E-mail: technical@mirashowers.com
Fax: 01242 282595
By Post: Cromwell Road, Cheltenham,
Gloucestershire, GL52 5EP

Eire

Modern Plant Ltd. (Dublin)

Telephone: 01 459 1344
Mon. to Fri. 9:00 am - 5:00 pm
E-mail: sales@modernplant.ie
Fax: Dublin 01 459 2329
Post: Otter House, Naas Road,
Clondalkin, Dublin 22

Modern Plant Ltd. (Cork)

Telephone: 021 496 8755
Mon. to Fri. 9:00 am - 5:00 pm
E-mail: cork@modernplant.ie
Fax: 021 496 8607
Post: Tramore Road, Cork



5 013181 038217 >

Mira is a registered trade mark of Kohler Mira Limited.

The company reserves the right to alter product specifications without notice.

www.mirashowers.com



FM 14648

mira
SHOWERS