

Mira Sport Max with Airboost

9.0 and 10.8 kW

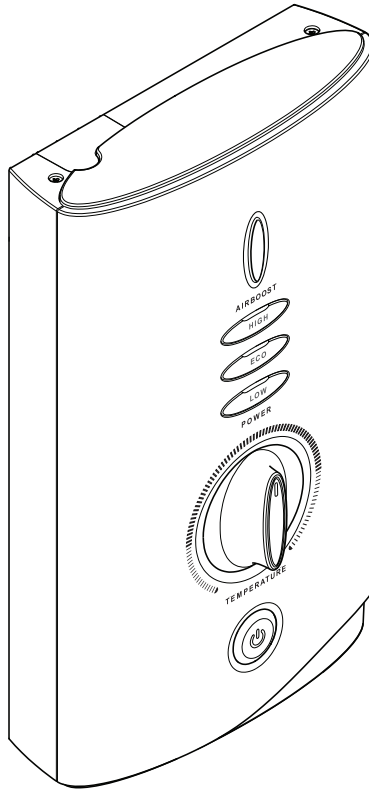

For Safety!
Before installing
or using this shower,
you **MUST** read this
guide.

**For SPARES,
ADVICE or REPAIRS**
please call us free
on 0800 001 4040
(UK only)

Installation and User Guide

These instructions must be left with the user

Showering perfection

mira
SHOWERS

Important Safety Information

Warning! This shower can deliver scalding temperatures, cause fire, electric shock or other personal injury if not operated, or maintained in accordance with the instructions, warnings and cautions contained in this guide and on the appliance.

Please read the important safety information and the operation section of this guide before using the shower. Failure to follow the information or instructions provided on or with this shower will invalidate the guarantee.

Warning! The shower head and hose supplied with this product are critical to its correct operation. When installing or exchanging an electric shower always fit and use the shower head and hose provided with the product.

If any future change of the shower head or hose is required only fit suitable Mira manufactured products. Non-Mira manufactured shower heads may not be suitable for electric showers. They can be very restrictive or stop the flow of water, this is dangerous and could lead to product damage, scalding or serious injury.

If you are unsure about the shower head and hose compatibility with your shower contact Mira Customer Services.

TO REDUCE THE RISK OF FIRE, ELECTRIC SHOCK OR INJURY:

1. Children younger than 3 years should not use this shower. Children 3 years to under 8 years should only use this shower under continuous supervision. Children aged 8 years and above and persons with reduced physical, sensory, or mental capabilities or lack of experience or knowledge can use the shower if they are given supervision or instruction concerning use of the appliance in a safe way and understand the hazards involved.
2. Children shall not be allowed to play with the shower.
3. Cleaning and user maintenance shall not be made by children.

4. **DO NOT** restrict the water flow from the shower outlet, temporarily bending the shower hose or blocking the shower head, such as placing against your body while in use can cause a very hot shot of water to be discharged.
5. The outlet must not be connected to any tap or fitting other than those specified.
6. The showerhead must be descaled regularly. Any blockage of the showerhead or hose can cause injury or scalding.
7. **Warning! DO NOT** switch on if there is a possibility that the water in the shower is frozen.
8. **Warning!** If the shower has symptoms of low or no flow from the outlet, immediately turn it off and **DO NOT** operate the shower. Any further diagnosis must be carried out with the power control set to low and the temperature control set to full cold.
9. This shower must be provided with means for local disconnection that is incorporated into the fixed wiring in accordance with the relevant local wiring regulations. This must be a double pole switch, which has at least 3 mm contact separation in each pole. The switch can be a ceiling mounted pull-cord type within the shower room or a wall mounted switch fitted in the applicable zone area.
10. Installation of the shower must be carried out in accordance with these instructions by qualified, competent personnel. Read all instructions before installing the shower.
11. **DO NOT** switch the shower on if water starts leaking from the shower case. Isolate the electrical supply to the shower immediately.
12. **DO NOT** switch the shower on if the case appears to be damaged or incorrectly fitted. Isolate the electrical supply to the shower immediately.
13. **DO NOT** increase the power setting or adjust the temperature control rapidly while using the shower. Move away from the shower and ensure the temperature has stabilised before re-entering the shower.

14. **DO NOT** switch the shower off and back on while standing in the water flow. Move away from the shower and ensure the temperature has stabilised before re-entering the shower.
15. **DO NOT** change the handset model. Fit only shower heads recommended by Mira and do not fit any additional device to restrict the water outlet flow.
16. When adjusting the handset mode, point handset away from body and make sure that the water temperature has stabilised before continuing to shower.
17. Use caution when altering the water temperature, always check the temperature before continuing to shower.
18. For Dual Head Products in low ambient room temperatures. **DO NOT** turn up the temperature control too high as the product may cycle Hot/Cold.
19. Switch the shower off at the electrical isolating switch when not in use. This is recommended with all electrical appliances.
20. Isolate the electrical and water supplies before commencing installation. The electricity must be isolated at the consumer unit and the appropriate circuit fuse removed, if applicable. Mains connections are exposed when the cover is removed.
21. **DO NOT** install the shower in areas with high humidity and temperature (i.e. Steam rooms and saunas).
22. **DO NOT** install the shower where it may be exposed to freezing conditions. Ensure that any pipework that could become frozen is properly insulated.
23. **DO NOT** connect the outlet of the shower to any tap, control valve, trigger operated handset or showerhead other than those specified for use with this shower as the outlet acts as a vent for the tank body. Only Kohler Mira recommended accessories should be used.
24. **DO NOT** perform any unspecified modifications, or drill or cut holes in the product other than instructed by this guide. When servicing only use genuine Kohler Mira replacement parts.

25. **DO NOT** connect this shower to a Waste Water Heat Recovery System as this may cause unstable or scalding temperatures to be delivered from the shower head.
26. Always check the water temperature is safe before entering the shower.
27. The water supply to this product must be isolated if the product is not to be used for a long period of time. If the product or pipework is at risk of freezing during this period they should also be drained of water.
28. If the shower is dismantled during installation or servicing then, upon completion, an inspection must be made to ensure all electrical connections are tight and that there are no leaks.
29. This appliance is intended to be permanently connected to the water mains and not connected by a hose set.
30. The water inlet of this appliance shall not be connected to a water supply obtained from any other water heating system.
31. **Warning!** This appliance is not to be used to provide a potable water supply.

If you are unsure about any of these Warnings & Cautions and require further explanation contact Mira Customer Services.

Pack Contents

Tick the appropriate boxes to familiarize yourself with the part names and to confirm that the parts are included.

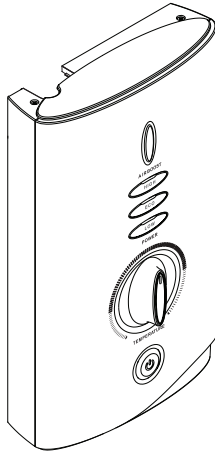

1 x Mira Sport Max with Airboost Electric Shower

1 x Olive



1 x Compression Nut



3 x Fixing Screws



3 x Wall Plugs

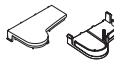

2 x Case Inserts

Documentation

1 x Quick Start Guide

1 x Energy Label

1 x Guarantee Brochure

1 x Warnings and Cautions Guide

Wiring Diagram

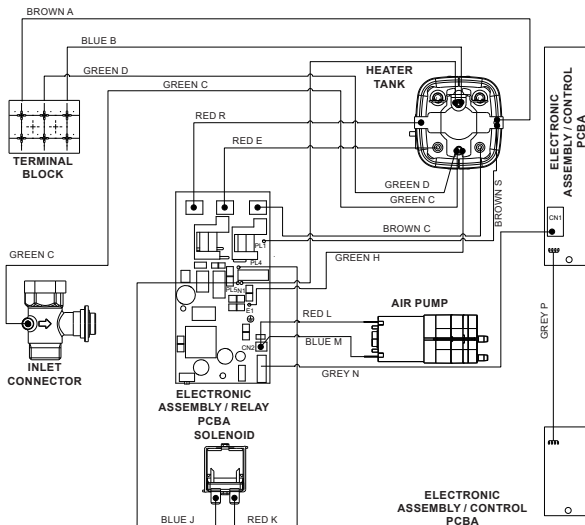

Internal Wiring Diagram

Introduction

Thank you for purchasing a quality Mira Sport Max with Airboost Electric Shower. To enjoy the full potential of your new shower, please take time to read this guide thoroughly, and keep it handy for future reference.

Products manufactured by Kohler Mira Ltd are designed to be safe provided, that they are installed used and maintained in good working order, in accordance with our instructions and recommendations.

Follow all warnings, cautions and instructions contained in this guide, and on or inside the shower.

The Mira Sport Max with Airboost electric showers have separate controls for power selection and temperature/ flow adjustment, in addition an Airboost function further enhances the showering experience. A unique flow regulator stabilises any temperature changes caused by water pressure fluctuations, which can result from taps being turned on or off or toilets being flushed.

Products Covered

Product Variant		Model No.	Colour
Sport Max with Airboost	9.0 kW	J03Gn	White/Chrome
Sport Max with Airboost	10.8 kW	J03Hn	White/Chrome
Sport Max Dual with Airboost	9.0 kW	J03P	White/Chrome
Sport Max Dual with Airboost	10.8 kW	J03Q	White/Chrome

Recommended Usage

Domestic	✓	Light Commercial	✗
Heavy Commercial	✗	Healthcare	✗

Patents and Design Registration

Design Registration:	001259287-0002, 001259287-0005
Patents:	GB: 2 427 460, 2 476 804

Guarantee

The Mira Sport Max with Airboost has been designed for domestic use only, Mira Showers guarantee the Mira Sport Max with Airboost against any defect in materials or workmanship for a period of two years from the date of purchase (shower fittings for one year).

For terms and conditions, refer to the back cover of this guide.

Disposal and Recycling

End of Product Life

Electrical and electronic devices contain a range of materials that can be separated for recycling and used in new products.



This product should not be disposed of with your general household waste. When this product has reached the end of its serviceable life, please remove any batteries and take it to a recognised WEEE (Waste Electrical and Electronic Equipment) collection facility such as your local civic amenity site for recycling.

Your local authority or retailer will be able to advise you of your nearest recycling facility.

Specifications

Plumbing	Sport Max with Airboost Variant	
	9.0	10.8
Minimum Dynamic Pressure	70 kPa (0.7 bar)**	100 kPa (1.0 bar)**
Maximum Dynamic Pressure *	500 kPa (5 bar)	
Minimum Static Pressure	20 kPa (0.2 bar)	
Maximum Static Pressure *	1000 kPa (10 bar)	
Maximum Inlet Temperature	30°C	
Minimum Inlet Temperature	2°C	
Inlet Connection	1/2" BSP Male / 15 mm Compression Fitting	
Maximum Water Hardness	200 ppm CaCO ₃	
Outlet Connection	1/2" BSP Male	

Electrical	Sport Max with Airboost Variant	
	9.0	10.8
Nominal Power at 230 V ac	8.3 kW	9.9 kW
Nominal Power at 240 V ac	9.0 kW	10.8 kW
Recommended MCB Rating	40 A	45 A
Maximum Supply Cable Size	16 mm ²	
Recommended RCD Rating	30 mA tripping current	
Recommended Isolator Switch	45 A double-pole with 3 mm contact separation	
Appliance Sealing Rating	IP X4	
Maximum Ambient Temperature	30°C	
Minimum Ambient Temperature	2°C	

Dimensions	
Height	358 mm
Width	215 mm
Depth	90 mm

*A drop tight pressure reducing valve should be installed where dynamic or static pressure exceeds the figure stated in the Specifications.

** For Dual Outlet Products: Minimum Dynamic pressure is 100 kPa (1.0 bar), For optimised performance Dynamic pressure should be >140 kPa (1.4 bar).

UK & EU Conformity Information

This product is in conformity with the relevant statutory requirements applicable to the product:

UK Legislation:

- S.I. 2016/1091 Electromagnetic Compatibility Regulations
- S.I. 2016/1101 Electrical Equipment (Safety) Regulations
- S.I. 2012/3032 Restriction of the Use of Certain Hazardous Substances in Electrical and Electronic Equipment
- S.I. 2010/2617 The Ecodesign for Energy-Related Products and Energy Information Regulations

EU Legislation:

- 2014/35/EU - Low Voltage Directive (LVD)
- 2014/30/EU - Electromagnetic Compatibility Directive (EMC)
- 2011/65/EU - Restriction of Hazardous Substances Directive (RoHS)
- (EU) No 814/2013 - Ecodesign requirements for water heaters and hot water storage tanks

This range of electric showers are high power appliances and are subject to conditional connection. If the main electrical supply fuse is rated less than 80 Amps, the local electricity supply company must be contacted to confirm if the electrical supply is adequate.

This range of showers complies with the requirements of the UK's water regulations.

Eco-Design/Energy Labelling

Product Information

Indicative annual electricity consumption (kWh), based upon 2100 Wh daily water energy demand. Actual electricity consumption will depend on kW rating and the duration and frequency of use.

	Mira	
	Sport Max	
kW Rating	9.0 kW	10.8 kW
Load Profile	XS	XS
Efficiency Class	A	A
Efficiency (%)	39	39
Annual Electricity Consumption (kWh)	472	474
Sound Power Level (dB)	57	57

Installation Requirements

Plumbing

1. The plumbing installation must comply with all national or local water regulations and all relevant building regulations, or any particular regulation or practice specified by the local water supply company.
2. **DO NOT** use any other shower fittings. Only install and use the shower hose and handset provided with this product.
3. **DO NOT** use sealing compounds on any pipe fitting or joints.
4. **DO NOT** install the product in a position in which service access is limited.
5. Decide on a suitable position for the shower (minimum distance of 200 mm from the ceiling to allow for cover fit and removal).
6. The position of the shower and shower fittings must provide a minimum gap of 25 mm between the showerhead and the spill over level of any bath, shower tray or basin and a minimum gap of 30 mm between the showerhead and the spill over level of any toilet, bidet or other appliance with a Fluid Category 5 backflow risk (see diagram on page 11).
7. The shower is suitable for installation within the shower area and is fitted with a pressure relief valve. It must be positioned over a water catchment area with the controls at a convenient height for the user.
8. **The shower must be fitted to a waterproof flat and even wall surface.**
9. **DO NOT** fit the shower to the wall and tile up to the case.
10. **DO NOT** seal the gap between the shower and the wall surface.
11. The showerhead should be positioned so that it discharges down the centre line of the bath or across the opening of a shower cubicle.
12. The showerhead must be directed away from the shower unit, during normal use the showerhead must not spray directly on to the shower unit.
13. **DO NOT** apply excessive force to plumbing connections; always provide mechanical support when making plumbing connections. Any soldered joints should be made before connecting the shower.
14. This shower is not designed to be plumbed directly from the rear. For rear-entry supply, add an elbow to the supply pipe and connect as a rising or a falling supply.
15. If pipework and/or electrical cables enter the shower from the rear through a hole in the wall provision must be made to prevent water ingress back into the wall structure.
16. Only use the inlet connector supplied with the shower. **DO NOT** use any other type of fitting.
17. A full bore/non restrictive servicing valve must be fitted in a readily accessible position adjacent to the shower to facilitate maintenance of the shower.
DO NOT use a valve with a loose washer plate (jumper) as this can lead to a build up of static pressure.

18. A water treatment device should be installed where the water hardness may exceed 200 ppm. Malfunctions caused by excessive limescale formation are not covered by this shower's guarantee (see back page for details).
19. The installation must not cause the hose to be sharply kinked during normal use.
20. **DO NOT** perform the electrical installation until the plumbing has been completed and checked for leaks.

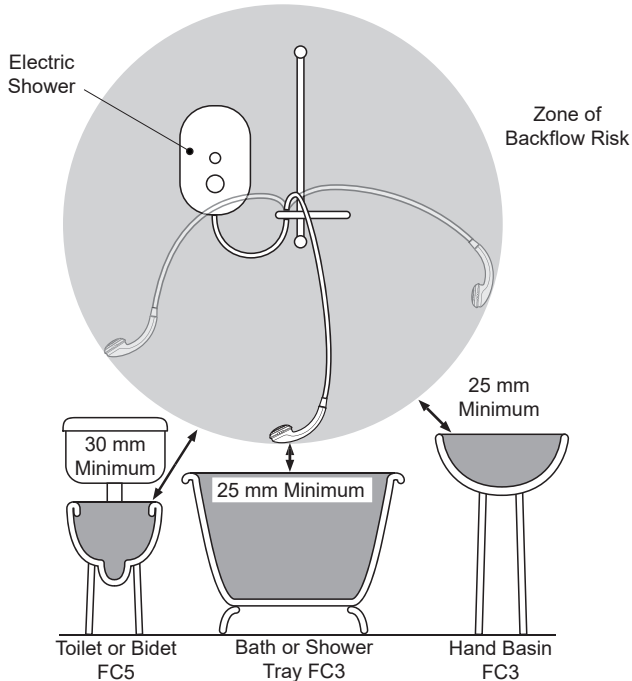

Hose retaining ring fitted and shower fittings fixed at a suitable height preventing dirty water backflow

Note: There will be occasions when the hose retaining ring will not provide a suitable solution for Fluid Category 3 installations, in these instances an outlet double check valve must be fitted, this will increase the required supply pressure typically by 10kPa (0.1 bar). Double check valves fitted in the inlet supply to the appliance cause a pressure build up, which affect the maximum static inlet pressure for the appliance and must not be fitted. For Fluid category 5 double check valves are not suitable.

Electrical

1. The electrical installation must comply with BS 7671 (commonly referred to as the IEE Wiring Regulations) and all relevant building regulations, or any particular regulation or practice specified by the local electricity supply company.
2. Ensure that all circuit protection devices, switches and cabling is adequate for the rated current of the shower and that the rating of the electricity supply company fuse and the consumer unit are adequate for the additional demand.
3. The shower **must** be earthed. Ensure any supplementary bonding complies with the relevant regulations.
4. This shower is intended to be permanently connected to the fixed electrical wiring of the mains system. A separate supply **must** be provided from the consumer unit to the shower.
5. **DO NOT** supply any other electrical equipment including extractor fans or pumps via this product.
6. This shower must be provided with means for local disconnection that is incorporated into the fixed wiring in accordance with the relevant local wiring regulations. This **must** be a double pole switch, which has at least 3 mm contact separation in each pole. The switch can be a ceiling mounted pull-cord type within the shower room or a wall mounted switch fitted in the applicable zone area.
7. A 30mA Residual Current Device (RCD) must be incorporated into the electrical supply to this shower in accordance with wiring regulations.
8. **DO NOT** apply excessive force to the terminal block.
9. All electrical connections should be checked for tightness to prevent overheating before switching on the electrical supply.
10. **DO NOT** switch on the electrical supply until the plumbing has been completed and checked for leaks.

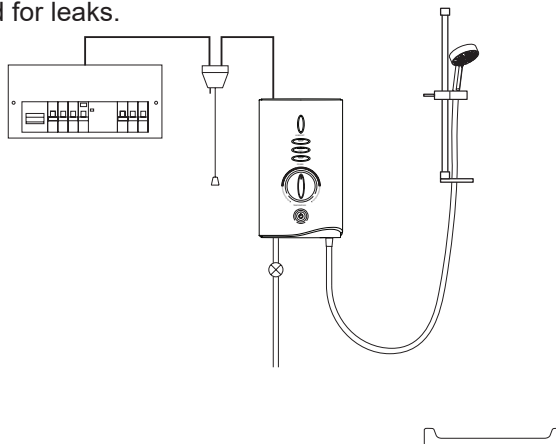

Plumbing and Electrical Schematic

Installation

Warning! Turn off the electrical and water supplies before proceeding with the installation of the shower.

1 Remove the three screws that hold the cover on and remove the cover.

2 Remove the service tunnel.

3 Using the holes in the case, mark the positions of the **three** fixing holes.

Note: Ensure that there are sufficient lengths of supply pipe and electrical cable to reach the connection points.

4 Remove the product and drill three holes to suit the fixing screws and wall plugs.

Caution! DO NOT drill into cables or pipes in the wall.

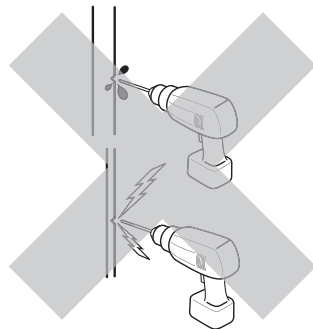
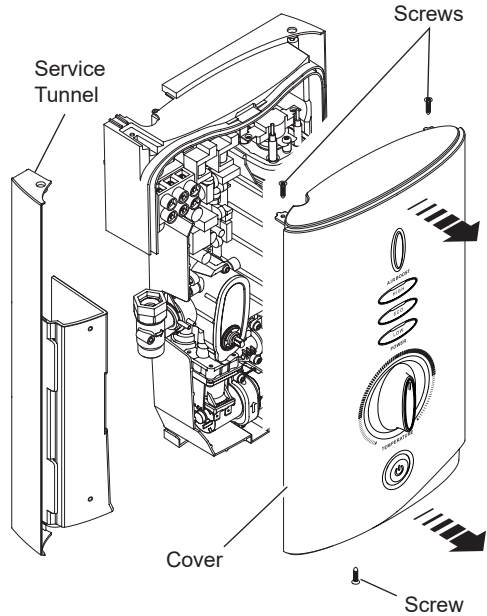
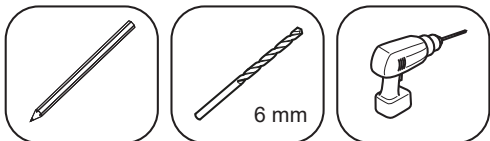

Caution! DO NOT drill into buried cables or pipes.

- 5 Determine the direction and route of the incoming water supply: falling (entering the shower from the top), or rising (entering the shower from the bottom).

NOTE: DO NOT use an incoming supply entering the shower directly from the back. Add an elbow to the supply pipe and connect it as a rising or falling supply.

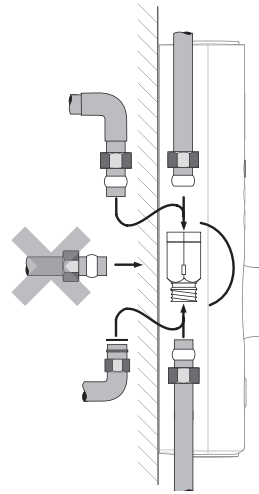

- 6 Thoroughly flush the supply pipe.

- 7 Rotate the inlet connector to suit the direction of the incoming water supply.

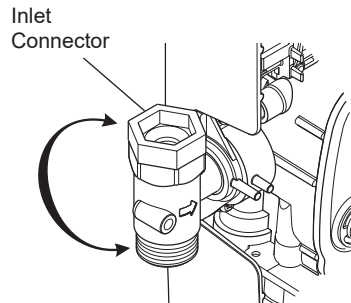

- 8 Upper and lower case inserts are supplied and should be fitted.

NOTE: Trim the inserts if necessary to fit incoming electrical or water supplies before fitting.

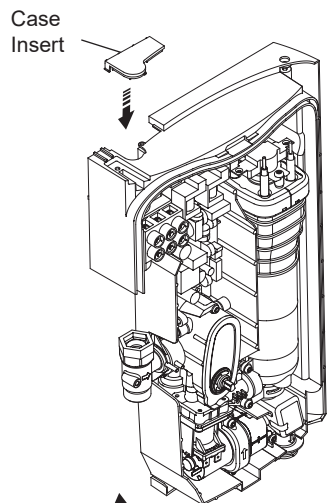

- 9 Secure the shower to the wall.

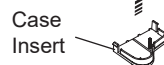

- 10** Connect the inlet supply pipe to the inlet connector using the compression nut and olive (supplied). Always provide mechanical support when making plumbing connections. Upon completion of the installation ensure connections and back case are not under any stress due to misaligned pipework or electrical cables.

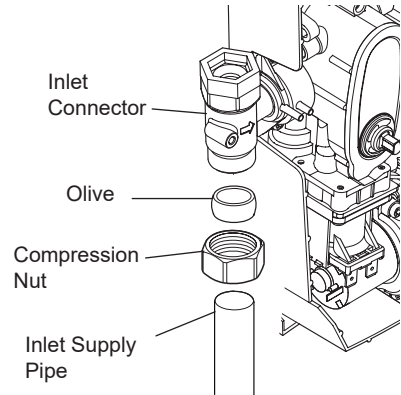

- 11** Turn on the water supply and check for leaks.

- 12** Strip back sufficient outer cable insulation to enable routing to terminal block.

- 13** Fit an earth sleeve to the earth wire.

- 14** Loosen the screws in the terminal block and insert the wires.

L (Live) = Brown wire

⊕ (Protective Earth) =
Green /Yellow sleeved wire

N (Neutral) = Blue wire

- 15** Tighten the screws in the terminal block, ensure the wires are secure and tight.

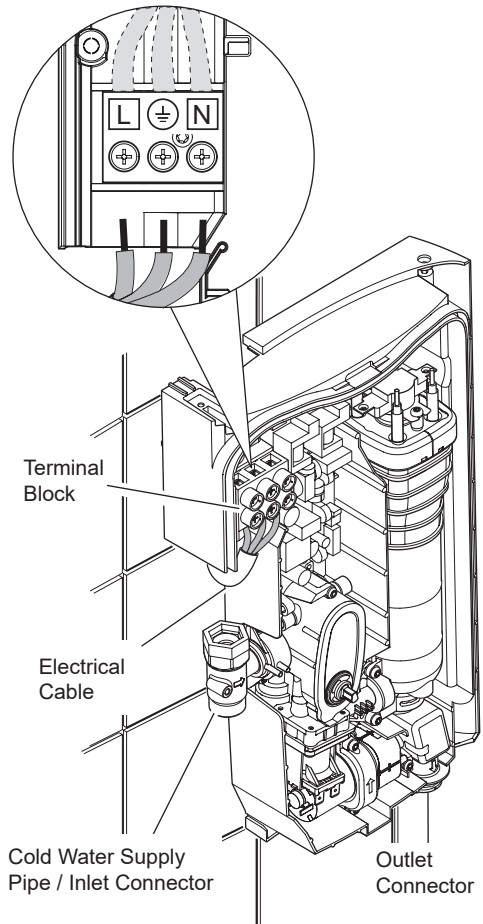

- 16** Ensure the earth bonding complies with relevant regulations.
- 17** Replace the service tunnel.
- 18** Plug the multi-connector into the cover PCB socket **Note:** The multi-connector will only locate correctly into the socket in one direction.
- Ensure the temperature control dial is aligned with the spindle then replace the cover.

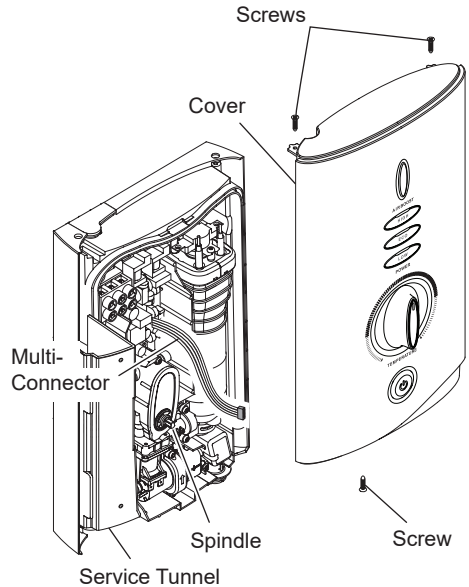

- 19** Tighten the three cover screws.

- 20** **DO NOT** use alternative screws to secure the cover. This can cause internal damage to the appliance.
- DO NOT** seal around the back of appliance.

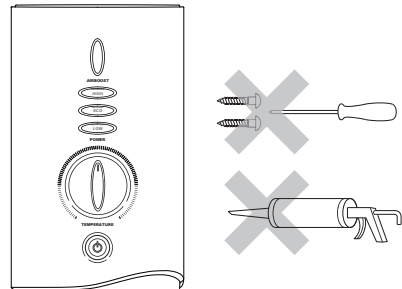

- 21** Install the shower fittings (Refer to the Shower Fittings Installation and User Guide on the Mira website - or linked with a QR code on the Quick Start Guide).
- 22** This completes the installation, follow the guidelines in section '**COMMISSIONING**' to prepare the shower for use.

Commissioning

1

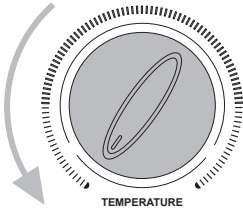

Turn temperature control to the cold position.

2



Switch on the electrical supply.

3

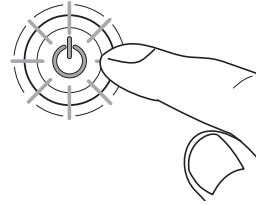

Push START/STOP button. Light in the button illuminates.

4

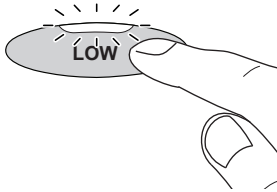

Push LOW button. Low button illuminates.
Note: When the Low, Eco or High button is pushed the Airboost Pump will activate for approximately 4 seconds.

5

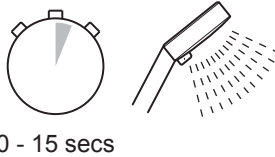

Water flows freely within a few seconds, temperature remains cool.

6

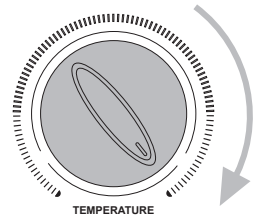

Slowly turn the temperature control to the hot position.

7

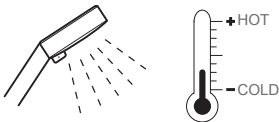

Flow is reduced and temperature remains cool.

8

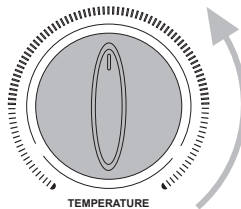

Turn temperature control back to the midway position.

9

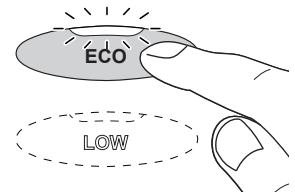

Push ECO button. Eco button illuminates

10

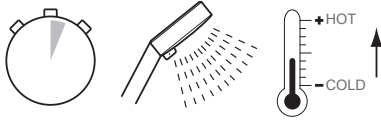

5 - 10 secs

Temperature will rise slightly.

11

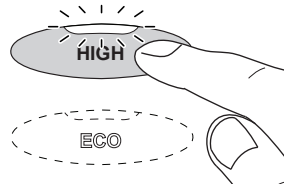

Push HIGH button. High button illuminates

12

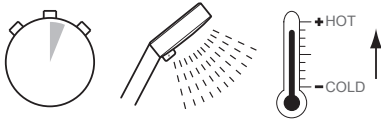

5 - 10 secs

Temperature will rise further.

13

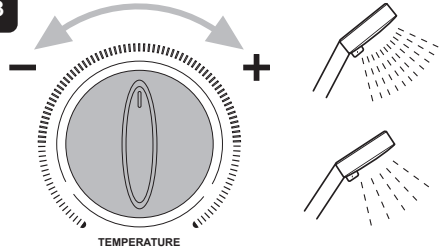

Adjust temperature as required. Flow rate will adjust automatically.

14

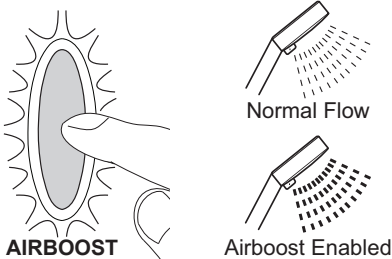

Check Airboost function. Aerated water will flow from the showerhead. Switch to overhead using the diverter and check aerated water will flow.

15

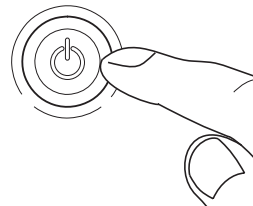

Push START/STOP button. Light in the button goes out.

16

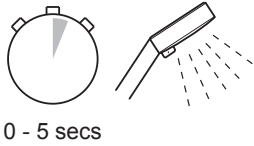

The shower will purge water from its tank for a few seconds.

17



Switch off the electrical supply.

Note: A slight hissing sound may be heard from the Mira shower during operation. High mains water pressure and high shower temperatures will affect the tone. This is quite normal in use.

Operation

Read the section “**IMPORTANT SAFETY INFORMATION**” first.

1



Switch on the electrical supply.

2



Push **START/STOP** button. Light in the button illuminates.*

3

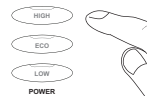

Push power button for the desired output. The button illuminates.

4

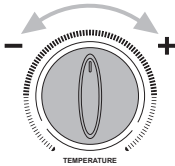

Adjust temperature as required. See *Important Information for Dual Head Products.

5

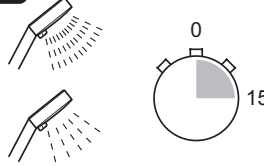

Allow 10 - 15 secs for any temperature adjustments to stabilise and reach the showerhead.

6

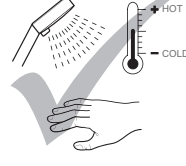

Check water temperature before entering shower.

7

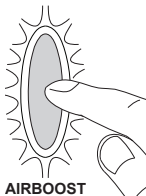

Push Airboost button if required. The Airboost button will illuminate and briefly flash.

8

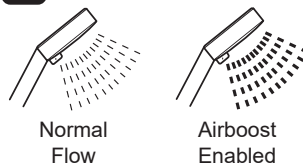

Aerated water flows from the showerhead or overhead depending on diverter position.

9

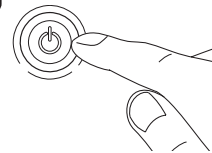

Push **START/STOP** button. Light in the button goes out and shower continues to run for a few seconds.

10



Switch off the electrical supply.

*** Important! For Dual Head Products.**

Using the overhead shower during winter months may require the desired outlet temperature to be increased. Cooler room temperatures could cause this to be increased too much and operate the cycling thermal switch. If the shower cycles hot/cold ensure shower heads are clean and reduce temperature at control.

11

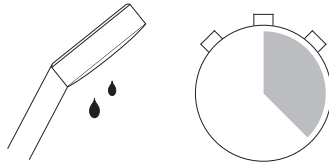

A small amount of water may continue to drain over a few minutes.

Warning! Turning the shower off and back on or adjusting the temperature control during showering may result in unstable temperatures at the showerhead. Always ensure the temperature has stabilised before re-using the shower.

DO NOT hold the showerhead against the body. This may cause product damage, injury or scalding.

DO NOT allow children to use the shower unsupervised or allow them to play with the shower fittings or controls.

Always make sure the shower hose is not kinked or damaged and the shower handset is not blocked before using the shower.

Note: A slight hissing sound may be heard from the shower during operation. High mains water pressure and high shower temperatures will affect the tone. This is quite normal in use.

* Airboost pump runs for 2 seconds to purge the air system.

Note: When the shower is **not** running or the STOP button has been pressed, the three white power button lights will fade to dim after a short time, indicating the shower has entered a "stand-by" mode.

A slight hissing sound may also be heard from the shower during operation. High mains water pressure and high shower temperatures will affect the tone. This is quite normal in use.

The Effect of Other Water Devices

Example of how shower temperature stabilises due to pressure changes.

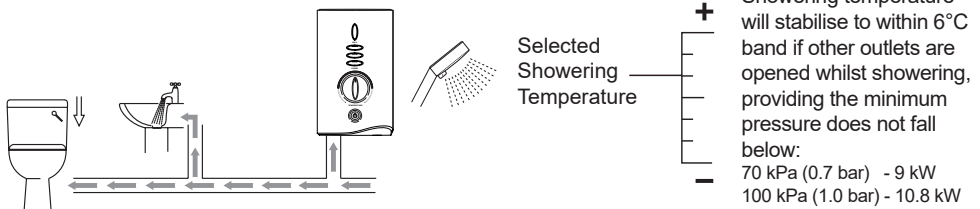

Water inlet pressure fluctuations due to other draw offs (e.g. flushing toilet) will cause the showering temperature to increase.

The Effect of Seasonal Changes

Incoming mains water temperature is not constant throughout the seasons of the year i.e. cooler during the winter, warmer during the summer, these changes can affect the outlet temperature of the shower, therefore the shower temperature may need to be increased or decreased to maintain the desired showering temperature.

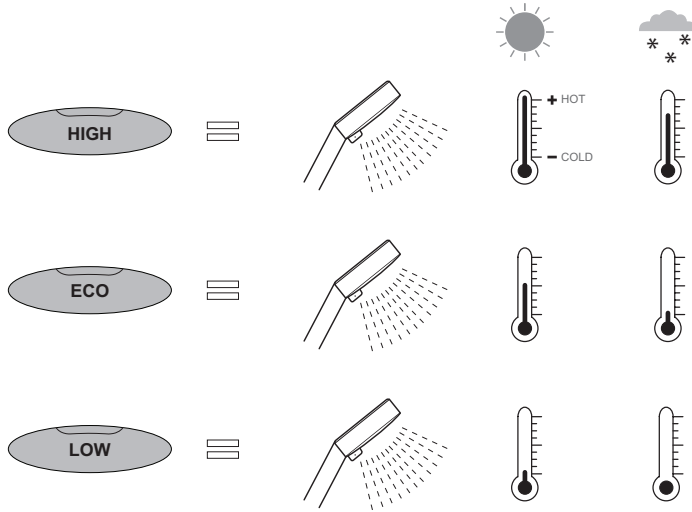

For a winter warm shower select HIGH

For a summer warm shower select ECO/HIGH

For a cold shower select LOW

Adjust the temperature as required

The flow rate will adjust automatically

User Maintenance

Always read the IMPORTANT SAFETY INFORMATION for your shower.

In the event of a malfunction of the shower, a fault finding table is provided in this guide detailing possible causes and remedies that may be carried out by non-qualified personnel.

WARNING! TO REDUCE THE RISK OF FIRE, ELECTRIC SHOCK, INJURY OR PRODUCT DAMAGE:

1. There are no user serviceable parts inside the shower. Only qualified, competent personnel should remove the front cover, mains connections are exposed when the cover is removed.
2. Switch the shower off at the isolator switch before performing any user maintenance or before cleaning the shower.

Cleaning the showerhead

Many household and commercial cleaners, including hand and surface cleaning wipes contain abrasive and chemical substances that can damage plastics, plating and printing and should not be used. These finishes should be cleaned with a mild washing up detergent or soap solution, and then wiped dry using a soft cloth.

De-scaling the Showerhead and inspecting the hose:

It is IMPORTANT to keep the showerhead and hose clean and free from blockage to make sure your shower performs to its optimum. The showerhead MUST be regularly cleaned and the hose MUST be regularly inspected to ensure there is no internal collapse or blockage that could reduce the flow.

1. Unscrew the shower hose from the shower then pull the Air Pipe Adaptor from the shower outlet.
2. Unscrew the shower hose from the Showerhead, pull out the Air pipe Diffuser. Ensure the diffuser holes are free from scale, clean if necessary.
3. Pull the Air Pipe Adaptor from the Air Pipe then withdraw the Air Pipe from the hose.
4. Inspect and replace the hose if necessary.
5. Reassemble parts in reverse order.

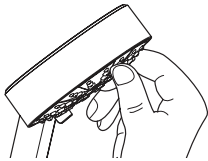

Use your thumb or a soft cloth to wipe any limescale from the soft nozzles

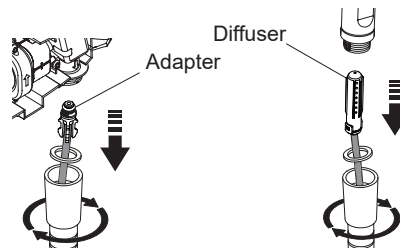

Unscrew the hose from the shower outlet and the showerhead.

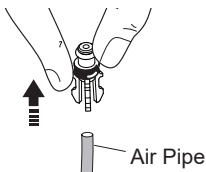

Inspect the hose.

Warning! Failure to keep the showerhead nozzles clear or inspect the hose for blockage or internal/external collapse can restrict the flow rate from the shower. This may cause damage to the shower or result in the temperature delivered to the user rising to unsafe levels with a risk of scalding. You MUST ALWAYS check the temperature before using the shower.

Fault Diagnosis

If the malfunction has not been detailed in the fault finding table or it was not possible to correct the malfunction, professional assistance may be required. Any fault diagnosis remedies **MUST** be carried out by a competent person or contact Mira Customer Services to arrange a service engineer.

Symptom	Power Control Position	Possible Cause	Possible Remedy
Shower fails to operate	ANY	Isolator switch in the off position.	Switch on electrical supply via the pullcord or wall mounted switch.
		Fuse blown or MCB/RCD tripped, indicating possible electrical fault.	Renew the fuse or reset the MCB/RCD. If fault persists, contact your installer.
Shower cycles from hot to cold	ECO/HIGH	The hose or showerhead is blocked.	De-scale showerhead, check hose for kinks or damage and replace if necessary. Refer to the ' USER MAINTENANCE ' section of this guide.
		Water pressure below minimum required for shower operation.	Make sure incoming mains water stopcock and/or shower isolating valve is fully turned on.
		Temperature control or heater setting too high.	Turn the power control to Eco or turn the temperature control until a cooler temperature is achieved.
Unable to select a cool enough shower	ECO/HIGH	Due to high water supply temperature, the heater setting may be too high.	Turn the power control to Eco or turn the temperature control until a cooler temperature is achieved.
		The hose or showerhead is blocked.	De-scale showerhead, check hose for kinks or damage and replace if necessary. Refer to the ' USER MAINTENANCE ' section of this guide.
Low flow	ANY	The hose or showerhead is blocked.	De-scale showerhead, check hose for kinks or damage and replace if necessary. Refer to the ' USER MAINTENANCE ' section of this guide.
		Other outlets (e.g. toilet, garden hose, washing machine, etc.) drawing water while the shower is being used.	Turn off other appliances whilst shower is in use.
Operation of Temperature Control has little or no effect on water temperature	ECO/HIGH	The hose or showerhead is blocked.	De-scale showerhead, check hose for kinks or damage and replace if necessary. Refer to the ' USER MAINTENANCE ' section of this guide.

Symptom	Possible Cause	Possible Remedy
No hot water from the shower, with the controls in ECO/HIGH position	Insufficient water supply pressure.	Contact local water authority.
	Potential product fault	Contact Mira Customer Services.
The shower temperature cycles between hot and cold with power control in ECO/HIGH	The showerhead spray plate is blocked.	Remove and clean the showerhead spray plate. Refer to the shower fittings User Guide. If the fault persists, contact Customer Services.
	The hose is blocked or kinked.	Clear the blockage or replace the hose
	The temperature is set too high. This is causing the thermal switch to turn off the heating element to reduce the water temperature.	Turn the temperature control anticlockwise to reduce the water temperature or turn the power control to ECO. DO NOT TAMPER with the thermal switch.
Turning the temperature control does not affect the water temperature	Potential product fault	Contact Mira Customer Services.
	The hose or showerhead is blocked.	De-scale showerhead, check hose for kinks or damage and replace if necessary. Refer to the User Maintenance section of the user guide.
The water cannot be turned off	Potential product fault	Contact Mira Customer Services.
No water or very low flow	The hose or showerhead is blocked.	De-scale showerhead, check hose for kinks or damage and replace if necessary. Refer to the User Maintenance section of the user guide.
	The incoming water supply stop valves, or the appliance isolating valve is closed.	Open the stop/isolating valve completely.
	Insufficient water supply pressure.	Contact the local water authority.
	Potential product fault	Contact installer or Mira Customer Services.
	The inlet filter is blocked.	Clean the inlet filter.
	The fuse is blown or the MCB / RCD has been tripped, indicating a possible electrical fault; for example, heater tank element failure.	Switch on the power at the double pole switch.
Water leaks from the bottom of the case near the outlet and there is no flow from the showerhead	The pressure relief valve in the tank has been triggered (usually due to a blocked outlet), when the relief valve operates a small rubber ball is ejected.	Contact installer or Mira Customer Services.
Airboost function is spluttering from the showerhead or overhead	The airboost function will give a pulsating type of showering experience and is normal but if it is very erratic the air pipe may have come detached from one end of the fittings.	Remove shower hose or overhead and refit diffuser or air pipe adaptor to the air hose.

Servicing

Always read the Important Safety Information before carrying out any servicing or maintenance.

Warning! There are no user serviceable parts inside the shower. Servicing of the shower must only be carried out by qualified, competent personnel following the instructions provided in this guide and those provided with any spare part. Before replacing any parts, ensure that the underlying cause of the malfunction has been resolved.

Cleaning the Inlet Filter

Warning! Isolate the electrical and water supplies before removing the cover.

- 1 Remove the shower hose. **Note:** Retain the Hose Washer for further use
- 2 Remove the three cover retaining screws and remove the cover.
- 3 Unplug the multi-connector and place the cover to one side.
- 4 Remove the service tunnel.
- 5 Use a suitable spanner to remove the filter from the inlet connector assembly. Hold a wrench across the flats of the inlet connector to prevent damage to the connector, whilst removing the filter.
- 6 Remove the filter and rinse under a running tap to remove any lodged particles. If necessary, use a kettle descalant in accordance with the manufacturer's instructions.
- 7 Refit the components in reverse order. **Note:** The multi-connector will only locate correctly into the cover socket in one direction.

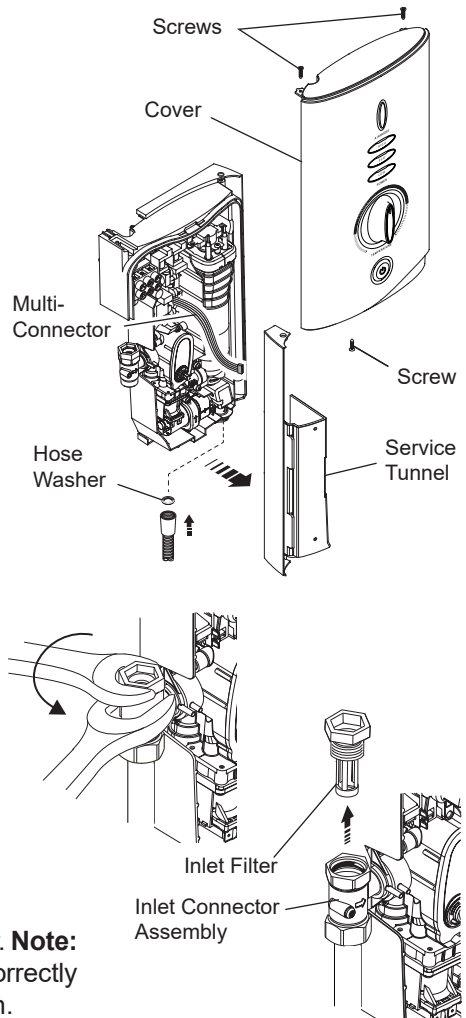

Customer Support

Guarantee

Your product has the benefit of our manufacturer's guarantee which starts from the date of purchase. This guarantee only applies in the United Kingdom and Republic of Ireland.

Activating Your Guarantee

Registering your guarantee is quick and simple. To ensure your product is covered, please register online.



Scan the QR code to activate your guarantee now or call 0800 5978551 within 30 days of purchase (UK only).

What is Covered:

- The guarantee applies solely to the original installation under normal use.
- The product must be installed and maintained in accordance with the instructions given in this guide.
- Servicing must only be undertaken by us or our appointed representative.
- Repair under this guarantee does not extend the original expiry date. The guarantee on any replacement parts or product ends at the original expiry date.
- For shower fittings or consumable items we reserve the right to supply replacement parts only.

The guarantee does not cover:

- Call out charges for non product faults (such as damage or performance issues arising from incorrect installation, improper use, inappropriate cleaning, lack of maintenance, build up of limescale, frost damage, chemical attack, corrosion, system debris or blocked filters) or where no fault has been found with the product.
- Water or electrical supply, waste and isolation issues.
- Routine maintenance or replacement parts to comply with the requirements of Building / Plumbing / Electrical Standards or Schemes.
- Compensation for loss of use of the product or consequential or indirect loss of any kind.
- Damage or defects caused if the product is repaired or modified by persons not authorised by us or our appointed representative.
- Accidental or wilful damage.
- Products purchased ex-showroom display.
- Disinfection or descaling to reduce bacterial growth or contamination.

What to do if something goes wrong

If your product is not working correctly please refer to this manual or the Mira website for fault diagnosis and to check that it is installed and commissioned in accordance with our instructions. If this does not resolve the issue, our Customer Services team are here to help get you back up and running. To help us solve your problem quickly, please have your product name, power rating (if applicable) and date of purchase to hand.

Visit www.mirashowers.co.uk

Visit our website to register your guarantee, book a service visit, diagnose faults and purchase products.

Spares and Accessories

We stock a full range of spare parts and fittings and are all available to purchase either online or over the phone. Our online spare parts selector tool will help you quickly and easily identify the spare part for your product.

Visit www.mirashowers.co.uk/parts-accessories

Replacements and Repairs

In the unlikely event that your product needs a repair, our nationwide repairs and installation team are here to help. You can book a convenient date and time online.



Scan the QR code to book a service visit now or visit www.mirashowers.co.uk/support/repair-services/repair-service

We also offer a comprehensive replacement service for when your product needs a little refresh, visit our website or contact our team for more information on our replacement services.

Help us improve

Your experience is important to us and your review (whether good, bad or otherwise) will be posted on [Trustpilot.com](https://www.trustpilot.com) immediately to help other people make more informed decisions.

Visit uk.trustpilot.com/review/www.mirashowers.co.uk

Need to get in touch?

UK

T: 0800 001 4040
E: askus@mirashowers.com
www.mirashowers.co.uk

Eire

T: 01 531 9337
E: customerserviceire@mirashowers.com
www.mirashowers.ie

Mira is a registered trade mark of Kohler Mira Limited.

The company reserves the right to alter product specifications without notice.

Registered Office:
Cromwell Road,
Chelltenham,
Gloucestershire
GL52 5EP

EU Importer address:
Kohler France S.A.S.
30 Boulevard de la Bastille,
75012 Paris,
France



mira
SHOWERS