

9.0 AND 9.8 kW

mira

Advance
ATL THERMOSTATIC

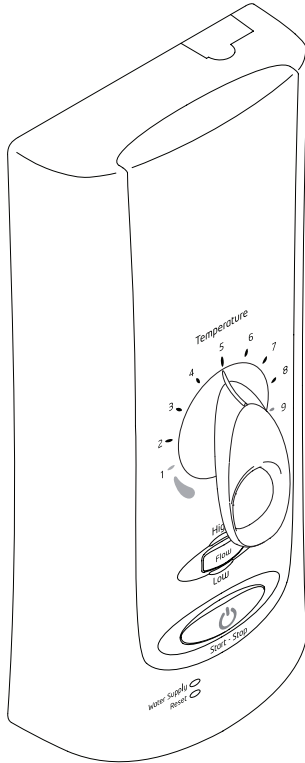

IMPORTANT!

Before finishing the installation, make sure that the shower has performed a single commissioning cycle successfully. Error conditions may occur as a result of not commissioning.

MIRA ADVANCE ATL
ADJUSTABLE TEMPERATURE LIMIT THERMOSTATIC

ELECTRIC SHOWER

Installation Guide

**This product is suitable for mains fed cold water only.
Please leave these instructions at the installation address.**

CONTENTS

Shower Models	3
Guarantee	4
Patents and Design Registration.....	4
Important Safety Information	5
Pack Contents	7
Specifications	8
Standards and Approvals	8
Dimensions.....	9
Installation Requirements	10
General.....	10
1. Plumbing	10
2. Electrical.....	11
Installation	14
Basic Post Installation Checks	17
Commissioning	18
Set Maximum Temperature and Commissioning Cycle.....	18
BEAB Care	20
Fault Diagnosis	21
1. Installer Troubleshooting Guide.....	21
2. Diagnostic Procedure	22
Error Code Table	23
Maintenance	26
Spare Parts	27
Wiring Diagram	29
Accessories	30
Customer Service	Back Cover

SHOWER MODELS

Mira Advance ATL models covered by this guide

Product Variant	Adjustable Temperature Limit	Memory Push Button Feature	Extended Lever Control	Drain Pump Compatible	Model No.
Standard 9.0 kW	✓	✗	✗	✗	J97A
Standard 9.8 kW	✓	✗	✗	✗	J97B
Flex 9.0 kW	✓	✗	✓	✗	J97C
Flex 9.8 kW	✓	✗	✓	✗	J97D
Memory 9.0 kW	✓	✓	✗	✗	J97E
Memory 9.8 kW	✓	✓	✗	✗	J97F
Standard Extra	✓	✗	✗	✓	J97G
Flex Extra	✓	✗	✓	✓	J97H

The following separate drain kits are required for the 'Extra' models:

- SDP124T - Mira Whale Tray Kit (complete with 50 mm gully)
- SDP134T - Mira Whale Wet Floor Kit (complete with wet gully for vinyl)

This product must only be used with a Whale Shower Drain Pump (included in the kits listed above).

If you experience any difficulty with the installation or operation of your new Electric Shower, then please refer to '**Fault Diagnosis**', before contacting Mira Showers. Our contact details can be found on the back cover of this guide.

Guarantee

For **domestic installations**, Mira Showers guarantee the Mira Advance ATL against any defect in materials or workmanship for a period of **two years** from the date of purchase (shower fittings for one year).

For **non-domestic installations**, Mira Showers guarantee the Mira Advance ATL against any defect in materials or workmanship for a period of **one year** from the date of purchase.

For Terms and Conditions refer to the back cover of this guide.

Recommended Usage	
Domestic	✓
Light Commercial	✓
Heavy Commercial	✘
Healthcare	✓

Patents and Design Registration

Design Registration:	000738141: 0003, 0006, 0007, 0009
Patents:	GB: 2269466, 2270370, 2298478, 2298479, 2298481

IMPORTANT SAFETY INFORMATION

Installation must be carried out in accordance with these instructions, and must be conducted by designated, qualified and competent personnel.

1. WARNING!

Follow all warnings, cautions and instructions contained in this guide, and on or inside the shower.

- 1.1. This shower can deliver scalding temperatures if not operated, installed or maintained in accordance with the instructions, warnings and cautions contained in this guide and on or inside the appliance.**
- 1.2. Products manufactured by us are safe and risk-free, provided that they are installed, used and maintained in good working order, in accordance with our instructions and recommendations.
- 1.3. This product is suitable for installation within Zone 1 and is rated IP X4.
- 1.4. Isolate the electrical and water supplies before commencing installation. The electricity must be turned off at the mains and the appropriate circuit fuse removed, if applicable.
- 1.5. Mains connections are exposed when the cover is removed.
- 1.6. Refer to the wiring diagram before making any electrical connections.
- 1.7. Make sure all electrical connections are tight, to prevent overheating.
- 1.8. Make sure that any pipework that could become frozen is properly insulated. The shower unit must not be fitted where it may be exposed to freezing conditions.
- 1.9. The water supplies to this product must be isolated if the product is not to be used for a long period of time. If the product or pipework is at risk of freezing during this period they should also be drained of water.
- 1.10. **DO NOT** operate this appliance if it is frozen. Isolate the electrical supply and allow to thaw. Check for leaks before reconnecting the electrical supply.
- 1.11. **DO NOT** install the product in a position in which service access is restricted.
- 1.12. If the shower is dismantled during installation or servicing then upon completion the product must be inspected to ensure there are no leaks.
- 1.13. If water leaks from the pressure relief valve, maintenance will be required before the shower can be safely used.
- 1.14. **DO NOT** fit any form of outlet flow control (e.g. trigger handsets) as the outlet acts as a vent for the tank body. Only Mira recommended outlet fittings should be used.
- 1.15. This product is not suitable for areas with high humidity (i.e. steam rooms).
- 1.16. **THIS APPLIANCE MUST BE EARTHED. MAKE SURE SUPPLEMENTARY BONDING COMPLIES WITH THE 'REQUIREMENTS FOR ELECTRICAL INSTALLATIONS' BS7671.** This electric shower is intended to be permanently connected to the fixed electrical wiring of the mains system.
- 1.17. This appliance must be provided with means for disconnection that is incorporated into the fixed wiring in accordance with the relevant local wiring

regulations.

- 1.18.** This appliance is suitable for installation within the shower area and may be fitted with a pressure relief valve. It must be positioned over a water catchment area with the controls at a convenient height for the user. The shower fitting should be positioned so that it discharges down the centre line of the bath, or across the opening of a shower cubicle, and **must be directed away from the appliance.**

2. Caution!

- 2.1.** Read all of these instructions and retain this guide for later use.
- 2.2.** The electrical installation must comply to 'BS 7671 - Requirements for Electrical Installations', commonly referred to as the IEE Wiring Regulations - Part 7, or any particular regulations and practices, specified by the local electricity supply company.
- 2.3.** The plumbing installation must comply with the requirements of UK Water Regulations/Bye-laws (Scotland), Building Regulations or any particular regulations and practices, specified by the local water company or water undertakers.
- 2.4.** Switch off the appliance at the electrical isolating switch when not in use. This is for safety and is recommended with all electrical appliances.
- 2.5.** This appliance is not suitable for use with any form of electronic timer. The shower must be shut down in accordance with the instructions contained in this installation guide, or the separate user guide.
- 2.6.** Having completed the installation, make sure that the user is familiar with the operation of the appliance.
- 2.7.** When this appliance has reached the end of its serviceable life, it should be disposed of in a safe manner, in accordance with current local authority recycling, or waste disposal policy.
- 2.8.** Please pass this guide on in the event of a change of ownership of the installation site.

PACK CONTENTS

Tick the appropriate boxes to familiarise yourself with the part names and to confirm that the parts are included.

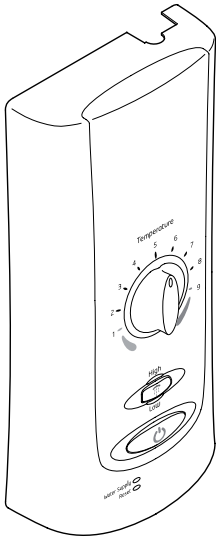

Or

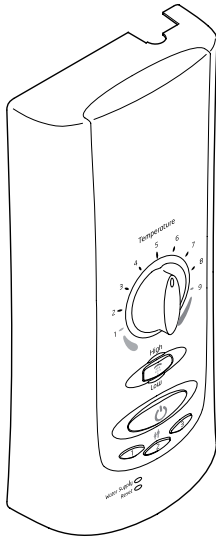

Or

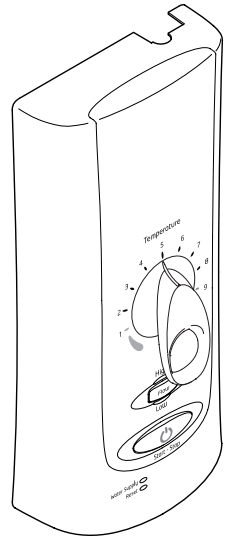

1 x Mira Advance ATL
Standard or Standard Extra
(Whale Shower Drain Pump
supplied separately)

1 x Mira Advance ATL
Memory

1 x Mira Advance ATL
Flex or Flex Extra
(Whale Shower Drain Pump
supplied separately)



1 x Compression Nut



1 x Olive



1 x Tap Connector Adaptor
(for fitting to existing tap connector)



2 x Wall Screws

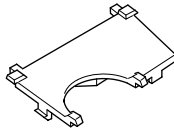

1 x Cover Insert Bottom

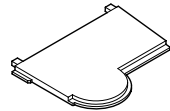

1 x Cover Insert Top

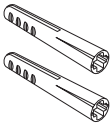

2 x Wall Plugs

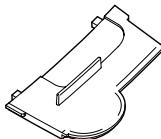

1 x Cover Insert Falling Supply

Documentation

- 1 x Installer Checklist
- 1 x Installation Template
- 1 x Guarantee Registration Document

SPECIFICATIONS

Plumbing Supply	Supply Source	Mains pressure cold water only	
	Minimum Dynamic Pressure*	50 kPa (0.5 bar)	
	Maximum Static Pressure	1000 kPa (10 bar)	
	Minimum Static Pressure**	20 kPa (0.2 bar)	
	Maximum Inlet Temperature	28°C	
	Minimum Inlet Temperature	2°C	
	Inlet Connection	½" BSP male & 15 mm compression fitting.	
	Outlet Connection	½" BSP male fitting	
Electrical Supply	Nominal Rating at 230 V	8.2 kW	9.0 kW
	Nominal Rating at 240 V	9.0 kW	9.8 kW
	Supply Fuse/Circuit Breaker	9.0 kW	40 Amps
		9.8 kW	45 Amps
	Residual Current Device RCD	30 mA	
	Supply Cable	No larger than 16 mm ² Note: Refer to current IEE regulations and BS 7671 to determine minimum cable size.	
	Isolation Switch	45 Amp Double pole, with 3 mm contact separation.	
Maximum Ambient Temperature	30°C		
Minimum Ambient Temperature	2°C		

* Recommended dynamic pressure of 100 kPa (1.0 bar) for full flow performance.

** Static pressure must never fall below 20 kPa (0.2 bar) when other draw offs are in use, e.g. flushing toilet. This is the minimum pressure required to keep the flow valve closed.

Standards and Approvals

The Mira Advance ATL complies with the requirements of the BEAB Care Mark Standard and the relevant directives for CE marking.

Dimensions

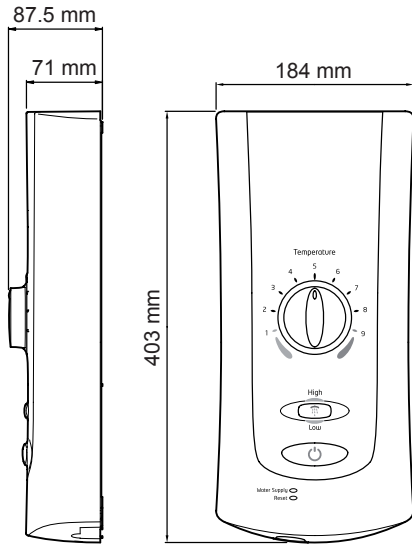

Advance ATL
Standard / Memory

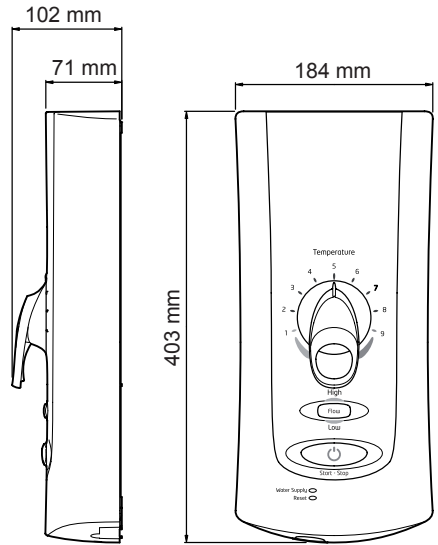

Advance ATL Flex

INSTALLATION REQUIREMENTS

General

This product works best when supply temperatures and pressures remain stable and within the product specifications, refer to section '**Specifications**'. If the supply conditions fall outside the specifications, the shower may go into a safe shut down condition.

If pipework and/or electrical cables enter the shower from the rear through a hole in the wall, provision must be made to prevent water ingress back into the wall structure.

1. Plumbing

Refer to section: '**Important Safety Information**' first.

- 1.1 Do not use sealing compounds on any pipe fittings or joints.
- 1.2 To avoid damage to the case when soldered fittings are used, pre-solder the pipework and fittings before connecting them to the inlet connector assembly.
- 1.3 Never fit the appliance to hot water supplies or to gravity systems of any description. Only fit the product to a mains cold water pipe.
- 1.4 Avoid layouts where the shower hose will be sharply kinked. This may reduce the life of the hose.
- 1.5 Supply pipework **MUST** be flushed to clear debris before connecting the appliance. Debris will reduce the performance of the shower.
Avoid running the pipework through excessively hot or cold areas such as hot loft spaces, airing cupboards, or in close proximity to hot water pipes. If this cannot be avoided, we would recommend insulating the pipes.
- 1.6 The shower must be fitted onto a tiled or sealed finished surface, i.e. on top of the tiles. **DO NOT** tile up to the sides of the shower or use a sealant around the case. Failure to do this may cause appliance failure. To ensure the case and other components are not put under strain during installation always provide mechanical support when making plumbing connections. Upon completion of the installation ensure connections and back case are not under any stress due to misaligned pipework or electrical cables.
- 1.7 We recommend that a non-restrictive (free flowing) isolating valve is fitted in the cold water supply pipe to allow maintenance of the appliance.
- 1.8 When installed in very hard water areas (above 200 ppm temporary hardness) your installer may advise the installation of a water treatment device, to reduce the effects of limescale formation. Any malfunction due to limescale is not covered by the manufacturer's guarantee. Your local water company will be able to advise the hardness of water in your area.
- 1.9 **Caution!** Double checkvalves, fitted in the inlet supply to the appliance, cause a pressure buildup, which could exceed the maximum static inlet pressure and cause water to leak into the appliance.

2. Electrical

Refer to section: '**Important Safety Information**' first.

2.1 In a domestic installation, the rating of the electricity supplier's fuse and the consumer unit must be adequate for the additional demand. All Mira Advance ATL electric showers are high power appliances. Voltage drop due to local heavy demand will reduce the shower's performance.

2.2 The appliance must be earthed by connecting the supply-cable earth conductor to the earth terminal.

Any supplementary bonding and supply cable size must conform to **BS 7671**.

2.3 As a guide only, and in accordance with **BS 7671** we recommend close circuit protection:

i.e. **9.0 kW = 40 Amp**

9.8 kW = 45 Amp

In accordance with **BS 7671**, a 30 mA Residual Current Device (RCD) **MUST** be included in the electrical circuit. This may be part of the consumer unit or a separate unit.

A separate, permanently connected supply must be taken from the consumer unit to the appliance through a double-pole switch, which has at least 3 mm contact separation. The switch can be a ceiling mounted pullcord type within the shower room or a wall mounted switch in the applicable zone area.

2.4 DO NOT exert strain on the terminal block. Make sure that the electrical connections are tightly screwed down.

2.5 DO NOT turn on the electrical supply until the plumbing has been completed.

2.6 Unless otherwise stated, electrical equipment such as extractor fans, pumps must not be connected via this product.

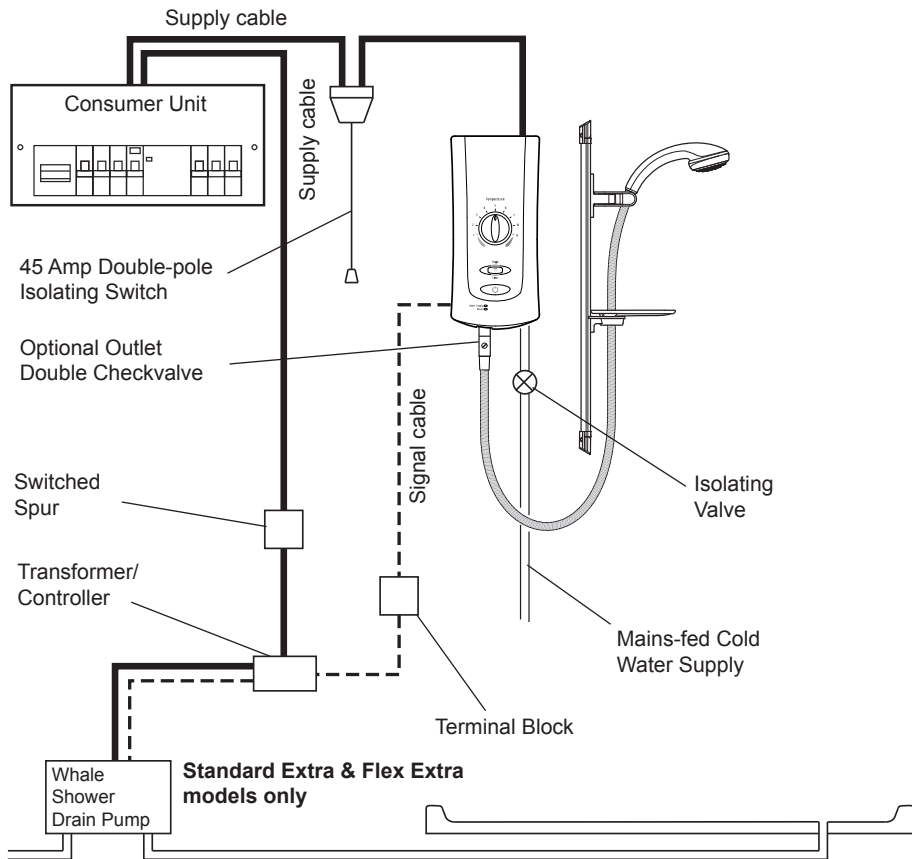

Plumbing and Electrical Schematic Diagram

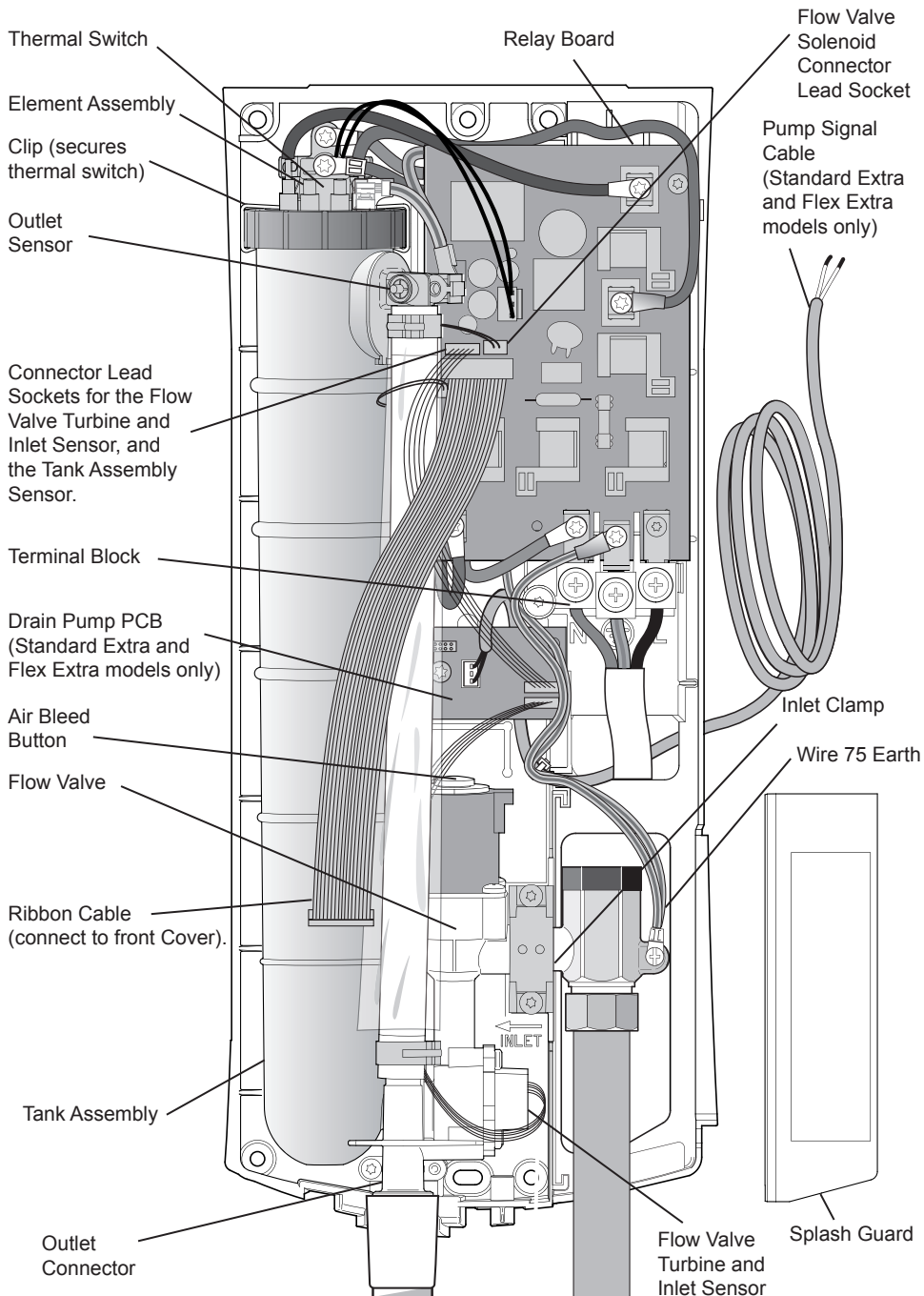

Mira Advance ATL
(Standard Extra and Flex Extra models shown)

INSTALLATION

Refer to section: 'Important Safety Information' first.

This installation covers all models of the Mira Advance ATL Thermostatic shower.

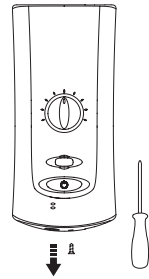
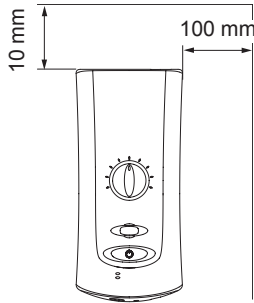

1. Electrical supply is turned off at the mains.
2. Determine the shower position, leaving adequate space for maintenance.
3. Remove cover screw.

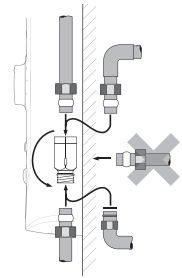
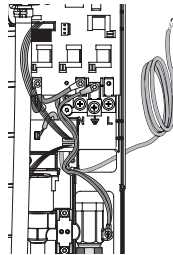
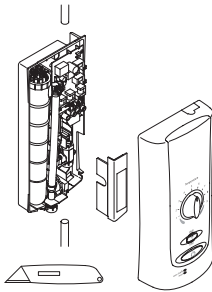

4. Remove the cover and splash guard. Determine supply pipe position and if required cut a slot in the case for the rising supply.
5. Make provision for signal cable to connect to shower drain pump (if applicable). Also refer to whale drain pump instructions.
6. Turn inlet connector to suit supply pipe. **Do not trap green wire.**

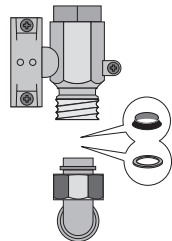
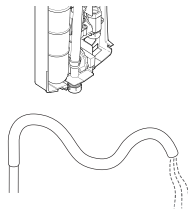
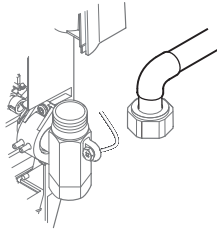

7. Complete any soldering required away from appliance.
8. Flush a minimum of 10 litres (2 gallons) through pipework prior to connection.
9. When fitting to a tap connection, use adaptor (supplied). **Do not fit fibre washer.**

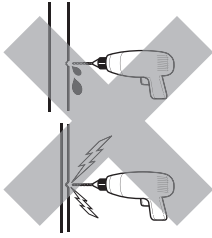

10. Caution! Do not drill into buried cables or pipes.

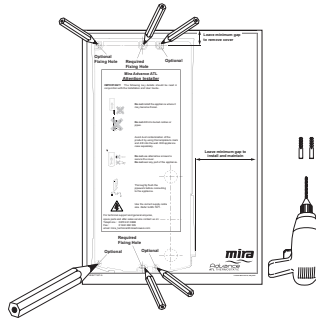

11. Use template provided to mark and drill required fixing holes. Screws and plugs are supplied for two required holes only.

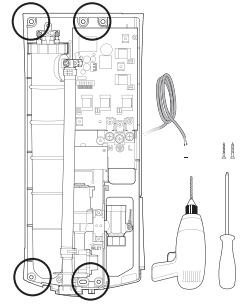

12. Drill holes through plastic case as required. Route signal cable to shower drain pump (if applicable). Fix appliance to wall.

13. Mira Advance ATL Standard Extra & Flex Extra variants only!

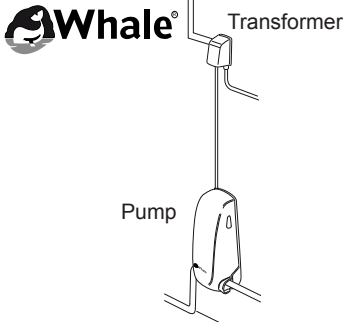

Find the whale shower drain pump transformer and identify it's type number.

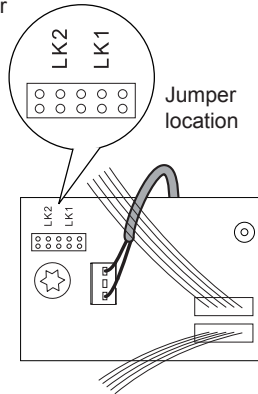

Type	Jumper
755.171	LK1
755.199	LK1
755.299	LK2
755.349	LK2
755.399	LK2
755.499	LK2

Jumper settings for Mira Advance ATL drain pump PCB.

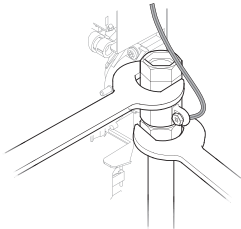

14. Connect supply pipe. **Do not** overtighten.

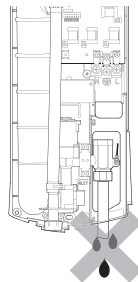

15. Turn on water supply and check for leaks.

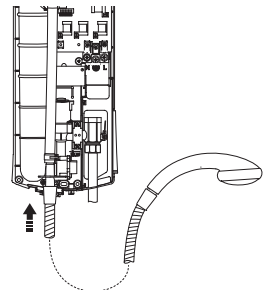

16. Connect hose and showerhead, pointing into bath or tray.

17. Important! Priming the Shower

Make sure electricity is isolated!

Push down and hold air bleed button to prime appliance until water appears from shower head. **Failure to prime will seriously affect shower performance!**

Carefully dry off water before connecting/reinstating electricity.

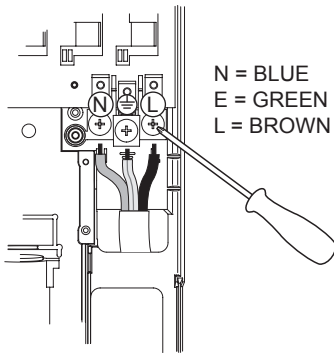
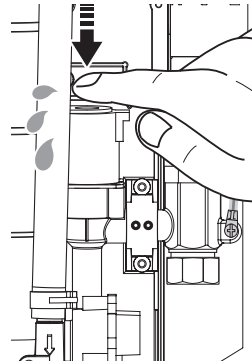

N = BLUE
E = GREEN
L = BROWN

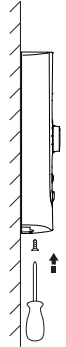
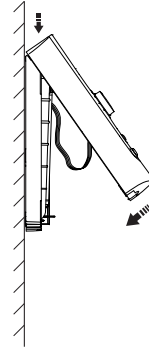
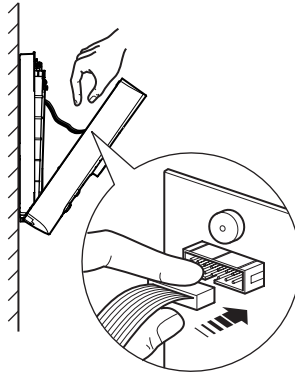

18. Feed cable into case. Fit earth sleeve and strip insulation. Firmly connect the conductors. **DO NOT** exert strain on terminal block.

19. Refit splash guard and connect ribbon cable to the inside of the cover.

20. Refit cover. Inserts are provided to finish the top and bottom as required.

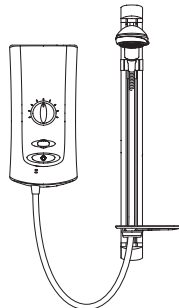
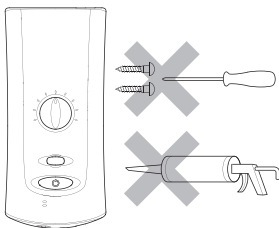

21. Do not use alternative screws to secure cover. This can cause internal damage to the appliance. Do not seal around any part of the appliance.

22. Install the shower fittings. Refer to separate Installation and User Guide.

Basic Post Installation Checks

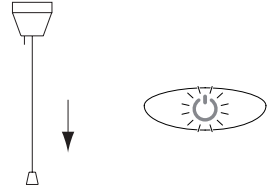
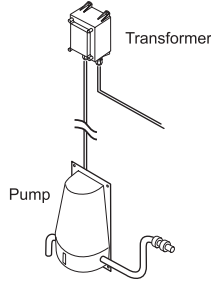

1. Turn on electrical supply.
2. Test shower drain pump (if applicable).
3. Power to appliance, check **Start/Stop** for blue light.

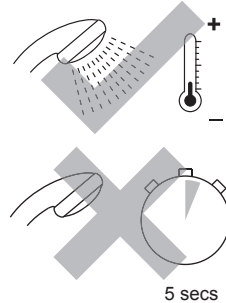
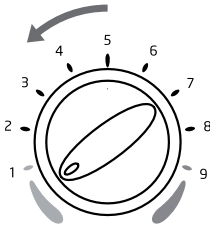

4. Temperature to full cold.
5. Start shower to test for water flow.
6. If there is no water after 5 seconds, make sure that the appliance has been **primed**.



7. Push **Start/Stop** to turn off the appliance. The pulsing light and "beep" indicates that the appliance is shutting down.
Important! DO NOT isolate the power to the appliance as this may result in a temporary malfunction.
8. The appliance will purge water from its tank for a few seconds.
Important! DO NOT isolate the power to the appliance.
Go to section: "**Commissioning**".

COMMISSIONING

On initial installation, the appliance needs to 'learn' about the site conditions and does so during the commissioning cycle.

It is important that the shower has performed a single commissioning cycle successfully. Error conditions may occur as a result of not commissioning.

Once set, the shower constantly updates it's memory with information about the site conditions to deliver the best performance.

DO NOT commission the appliance if water leaks from the unit.

Set Maximum Temperature and Commissioning Cycle

1. Shower is **OFF**.
Water has **STOPPED** flowing.
Power/Electric is **OFF**.

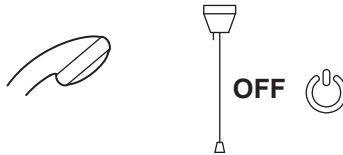

2. Set Maximum Temperature.
(See also section: "**BEAB Care**".)

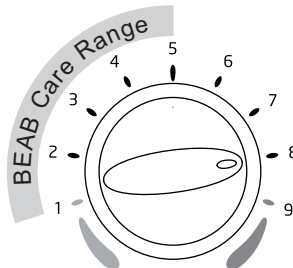



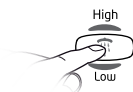
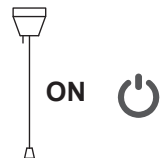

No.	Max. Temp °C
1	37
2	38
3	39
4	40
5	41
6	42
7	45
8	48

3. Turn Power/Electric **ON**.



Within 30 seconds push and hold **FLOW & START/STOP**..



4.   1st Beep (LONG) - Release **START/STOP**. 
 2nd Beep (SHORT) - Release **FLOW**. 

5. HIGH FLOW LIGHT FLASHES

This indicates the shower is commissioning.
 Water flows for approximately 1 minute 20 seconds.
 In some cases the cycle can take up to 3 minutes.
 Allow the shower to stop automatically.
IMPORTANT! DO NOT INTERRUPT THE CYCLE!



COMMISSIONING FAILURES

(the commissioning cycle was stopped due to an error)

No flashing FLOW LIGHT... solution ...Restart the commissioning cycle.

No water after 5 seconds... solution ...Reprime the shower. (See "Installation".)

WATER SUPPLY or

RESET light is on..... solution ...Reprime the shower. (See "Installation".)

6. Push **START/STOP** to turn the shower **ON**.
 Check that the maximum temperature is acceptable to the user.



7. Push **START/STOP** to turn the shower **OFF**.
 Wait until the water has stopped flowing **BEFORE** turning the Power/Electric **OFF**.

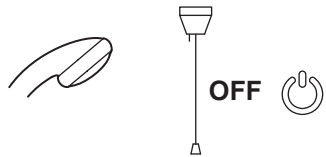

8. Residual water may drain over a few minutes.



BEAB Care

If the shower's maximum temperature is set to 41 °C or cooler, there is a clear triple beep tone and single pulse of the **Start/Stop** light every time the double pole switch is turned on. This is to show that the appliance is in a '**BEAB Care**' compliant mode. If recommissioning is required whilst in this mode, wait until beeps have passed before starting the commissioning cycle.

Memory Model

If the maximum temperature is adjusted **after** having been stored in one or more of the memory buttons (refer to section: '**Operation, Storing the Memory Presets**'), then the showering temperature cannot exceed the **new maximum setting**.

E.g.

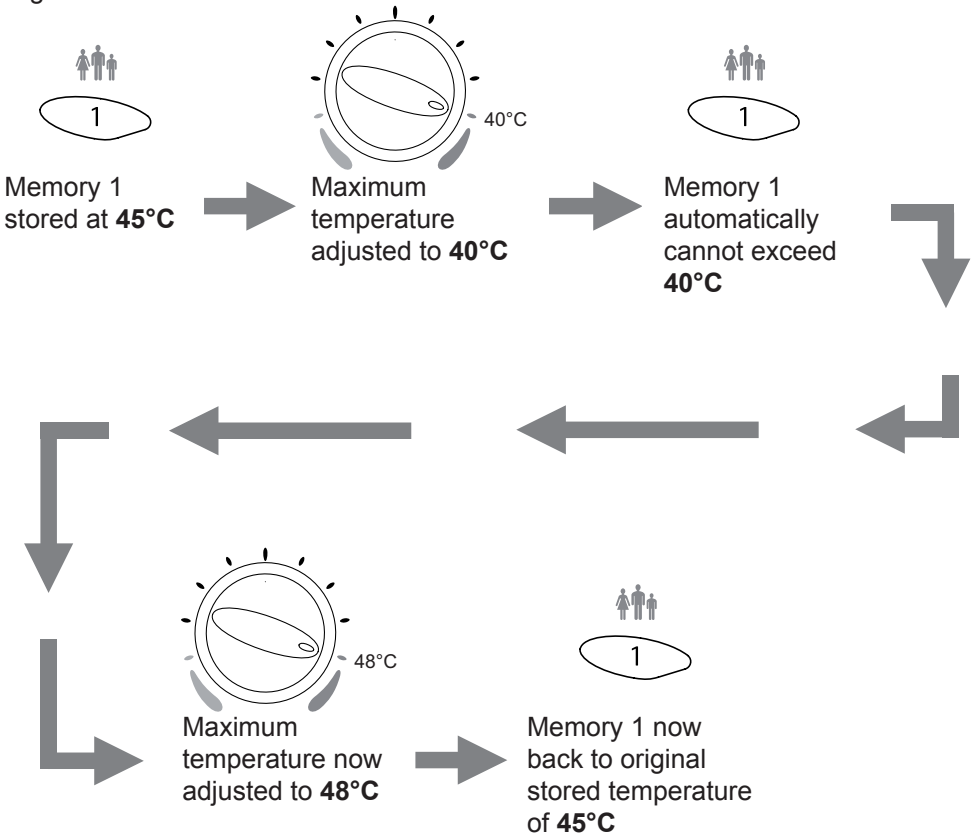

FAULT DIAGNOSIS

1. Installer Troubleshooting Guide

Refer to section: '**Important Safety Information**' first and refer also to '**User Trouble Shooting Guide**'.

The following troubleshooting solutions may require the removal of the cover of the shower. The cover should only be removed by a competent tradesperson and when doing so they should be aware of the following:

- Isolate the electrical and water supplies before initially removing the cover.
- Make sure Ribbon Cable is disconnected when removing the front cover and reconnect when maintenance is complete.
- Mains connections are exposed when the cover is removed.
- Refer to wiring diagram before making any electrical connections.
- Make sure all electrical connections are tight to prevent arcing/overheating.
- Make sure all plumbing connections are watertight.

When following these instructions, it is sometimes necessary to examine the appliance with the electrical and water supplies turned **on**. It is therefore essential that the appropriate safe working practices are followed in accordance with the current Health and Safety Legislation.

If conducting a continuity check using a multimeter, make sure the electrical supply is **ISOLATED**.

2. DIAGNOSTIC PROCEDURE

1. Ensure the shower pullcord / isolator switch is in the **OFF** position, then turn **ON** the pullcord / isolator switch.
2. If the unit 'Beeps' & the Start / Stop button is flashing **WAIT for 20 SECONDS** until the button stops flashing.

NOTE! If the Start / Stop button continues to flash & no beep was heard upon start up, then the failure is due to a sticking switch on the Control PCB - Refer to **ERROR CODE 16** on the fault code sheet.

3. Start the shower & observe light fault indication (if any) & refer to Error Code Sheet to determine failure and rectify.

NOTE! If the shower operates normally run the unit for at least 5 minutes at showering temperature & ensure the temperature remains stable.





























4. Turn the shower off at the Start / Stop Button & observe 'phased shutdown'. **DO NOT** isolate the power at the pullcord / isolator switch until the water flow stops.
5. Turn off the power at the pullcord / isolator switch, then turn the power back on and commission the shower.
6. Run the shower for at least 5 minutes.
7. Show the user the correct start / stop procedure and general operation of the shower. Advise user that isolating the shower before the flow has stopped may damage the shower.

For all fault codes 0 to 14 the reset light will be on or flashing. This will require the shower to be turned off at the pullcord / isolator switch to reset the unit. When the pullcord / isolation switch is turned back on the shower may beep and the Start / Stop button may flash. If this occurs go back to action number 2 and re-follow the Diagnostic Procedure.





Advance² Error Codes X - 7 / Display, Causes and Rectification

No light ○ Flashing light  Solid light ●

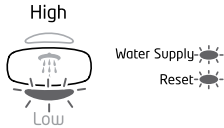
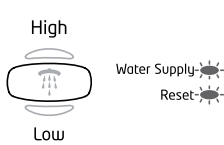
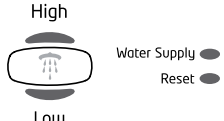
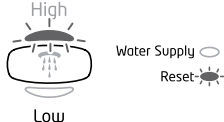
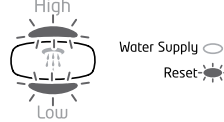
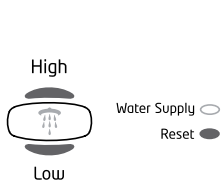
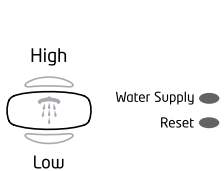
For all fault codes 0 to 14 the Reset light will be on or flashing. This will require the shower to be turned off at the pullcord / isolator switch to reset the unit. When the pullcord / isolation switch is turned back on the shower may beep and the Start / Stop button may flash. If this occurs go back to action number 2 and re-follow the Diagnostic Procedure

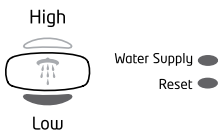
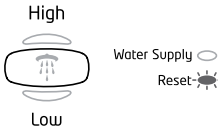
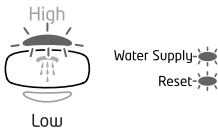
Error Code	Indicator Display	Possible Cause/Rectification
X	All lights in a normal state	No fault found
A	Water Supply-  OR  Reset 	Problem with water supply, unit still operates. <ol style="list-style-type: none"> 1. Check all isolator valves are fully open. 2. Clean / replace filter, refer to section: 'Maintenance'. 3. Check Inlet Temperature not too high. 4. Blocked Hose / Handset.
0	High   Low  Water Supply  Reset 	An unidentified error has occurred. <ol style="list-style-type: none"> 1. Replace Control PCB / Cover.
1	High   Low  Water Supply  Reset 	Incoming flow too low for appliance to operate safely. <ol style="list-style-type: none"> 1. Check all plumbing isolator valves to the shower are turned fully on 2. Reset - Commission the shower. 3. Blocked or partially blocked filter. 4. A section of the supply pipe may be frozen (thaw). (Advise customer of incorrect installation) 5. Replace Flow Valve. 5. Replace Thermal Switch. 6. Replace Heater Tank.
2	High   Low  Water Supply  Reset 	Internal electrical supply problem. <ol style="list-style-type: none"> 1. Replace Relay Board. 2. Replace Control PCB / Cover. 3. Replace Thermal Switch.
3	High   Low  Water Supply  Reset 	
4	High   Low  Water Supply  Reset 	Appliance has been incorrectly shut down. <ol style="list-style-type: none"> 1. Replace Relay Board & Control PCB / Cover TOGETHER. Advise the user on correct start/stop procedure and general operation of the shower, refer to User Guide.

5		<p>Incoming water temperature too high.</p> <ol style="list-style-type: none"> 1. Check inlet water temperature is not too high. 2. Replace Flow Valve. 3. Replace Control PCB / Cover.
6		<p>Flow Valve Assembly is disconnected or faulty.</p> <ol style="list-style-type: none"> 1. Check Multiway Cable Connection. 2. Check Flow Valve connection. 3. The shower or a section of the supply pipe may be frozen. 4. Replace Flow Valve. 5. Replace Control PCB / Cover.
7		<p>False flow reading.</p> <ol style="list-style-type: none"> 1. Replace Flow Valve.
8		<p>Safety relay failure.</p> <ol style="list-style-type: none"> 1. Check relay contacts. (debris on contacts or welded closed) 2. Check Multiway Cable Connection. 3. Replace Relay Board. 4. Replace Control PCB / Cover. 5. Replace Thermal Switch.
9		<p>Safety relay failure.</p> <ol style="list-style-type: none"> 1. Check relay contacts. (debris on contacts or welded closed) 2. Check Multiway Cable Connection. 3. Replace Relay Board. 4. Replace Control PCB / Cover. 5. Replace Thermal Switch.
10		<p>Internal Electrical Supply problem / Faulty Control PCB or Relay Board. Appliance has been incorrectly shut down.</p> <ol style="list-style-type: none"> 1. Push bleed button to flush the heater tank. 2. Replace Relay Board & Control PCB / Cover TOGETHER. <p>Advise the user on correct start/stop procedure and general operation of the shower, refer to User Guide.</p>
11		<p>Outlet Sensor faulty or disconnected from Relay Board or faulty Control PCB.</p> <ol style="list-style-type: none"> 1. Check Outlet Sensor connection to the Relay Board. 2. Check Multiway Cable Connection. 3. Replace Control PCB / Cover. 4. Replace Relay Board. 5. Replace Heater Tank.

12		<p>Unsafe hot water detected.</p> <ol style="list-style-type: none"> Unit incorrectly shut down causing hot water to trip the max temp limit, this would be following ERROR 17. Hot water in the heater tank, bleed via the blue button. Check Outlet Sensor connection to the Relay Board. Check Multiway Cable Connection. Replace Control PCB / Cover. Replace Relay Board. Replace Heater Tank. <p>Advise the user on correct start/stop procedure and general operation of the shower, refer to User Guide.</p>
13		<p>This failure only occurs during commissioning.</p> <ol style="list-style-type: none"> Check operation of relays / replace Relay Board Replace Flow valve. Replace Control PCB / Cover. Check resistance of Heater Tank elements./ replace Heater Tank.
14		<p>Error lights when unit is re-started.</p> <p>This error occurs when the shower has been incorrectly shutdown and the unit senses over temperature (refer to ERROR 17).</p> <p>Advise the user on correct start/stop procedure and general operation of the shower, refer to User Guide.</p>
15	 <p>Lights flashing in peculiar ways.</p>	<p>Unit fails to start.</p> <ol style="list-style-type: none"> Replace Relay Board and Control PCB / Cover TOGETHER.
16		<p>High & Low or Start / Stop lights pulsing rapidly.</p> <ol style="list-style-type: none"> Associated Button stuck / Replace Control PCB / Cover.
17		<p>Start / Stop Lights Pulsing Slowly</p> <ol style="list-style-type: none"> If a 2 second beep and the Start / Stop button is pulsing SLOWLY = Appliance has been incorrectly shut down. Refer to Diagnostic Procedure action number 2. <p>Advise the user on correct start/stop procedure and general operation of the shower, refer to User Guide.</p>

Unattended Operation

The appliance has a built in 'Shower Stop' timer to protect from accidental unattended operation. This feature automatically switches the shower off after 40 minutes of continuous use. Normal operation is restored by re-selecting the **Start/Stop** button.

MAINTENANCE

Tradesperson Maintenance - Inlet Filter Cleaning/Replacing

Read the section 'Important Safety Information' first.

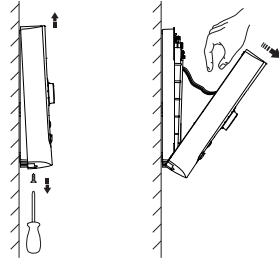
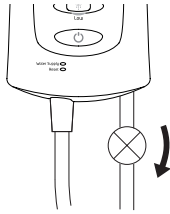

1. Electrical and water supplies to the appliance are turned off.
2. Remove the cover screw, cover and splash guard. Disconnect the ribbon cable from the cover

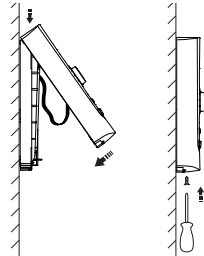
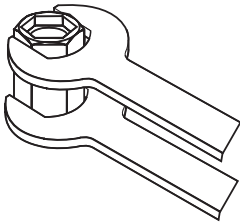

3. Hold a wrench across the flats of the metal connector. Unscrew the filter using another wrench as shown. Clean or replace the filter as necessary. Refit the filter making sure it is screwed fully home. **Do not overtighten.**
4. Make sure all plumbing connections are sealed before restoring the water supply. **Re-prime the appliance** (refer to 'Installation') before restoring the electricity supply. Refit the splash guard, ribbon cable and cover.

SPARE PARTS

405.58	Inlet Connector Assembly
406.27	Inlet Filter.
416.38	Clamp Bracket
1643.100	Thermal Switch.
1643.101	Tank Assembly 9 kW/230 V 9.8 kW/240 V (earth wire not included).
1643.102	Tank Assembly 8.2 kW/230 V 9 kW/240 V (earth wire not included).
1643.103	Terminal Block/Earth Wire/Neutral Wire.
1643.104	Relay Board (including screws).
1643.105	Top and Bottom Cover Inserts (white).
1643.112	Drain Pump PCB - Extra models only.
1643.113	Component Pack (components identified 'B').
1643.114	Splash Guard.
1643.144	Top and Bottom Cover Inserts (grey).
1643.148	Seal Pack (components identified 'A').
1643.149	Flow Valve Assembly (components identified 'C').
1643.251	Cover and PCB Assembly (Standard)
1643.252	Cover and PCB Assembly (Flex)
1643.255	Cover and PCB Assembly (Memory)

Warning! If the wiring layout is changed or amended, the product functionality and safety may be affected.

Warning! In the interests of safety, spares requiring exposure to mains voltage should only be fitted by competent persons.

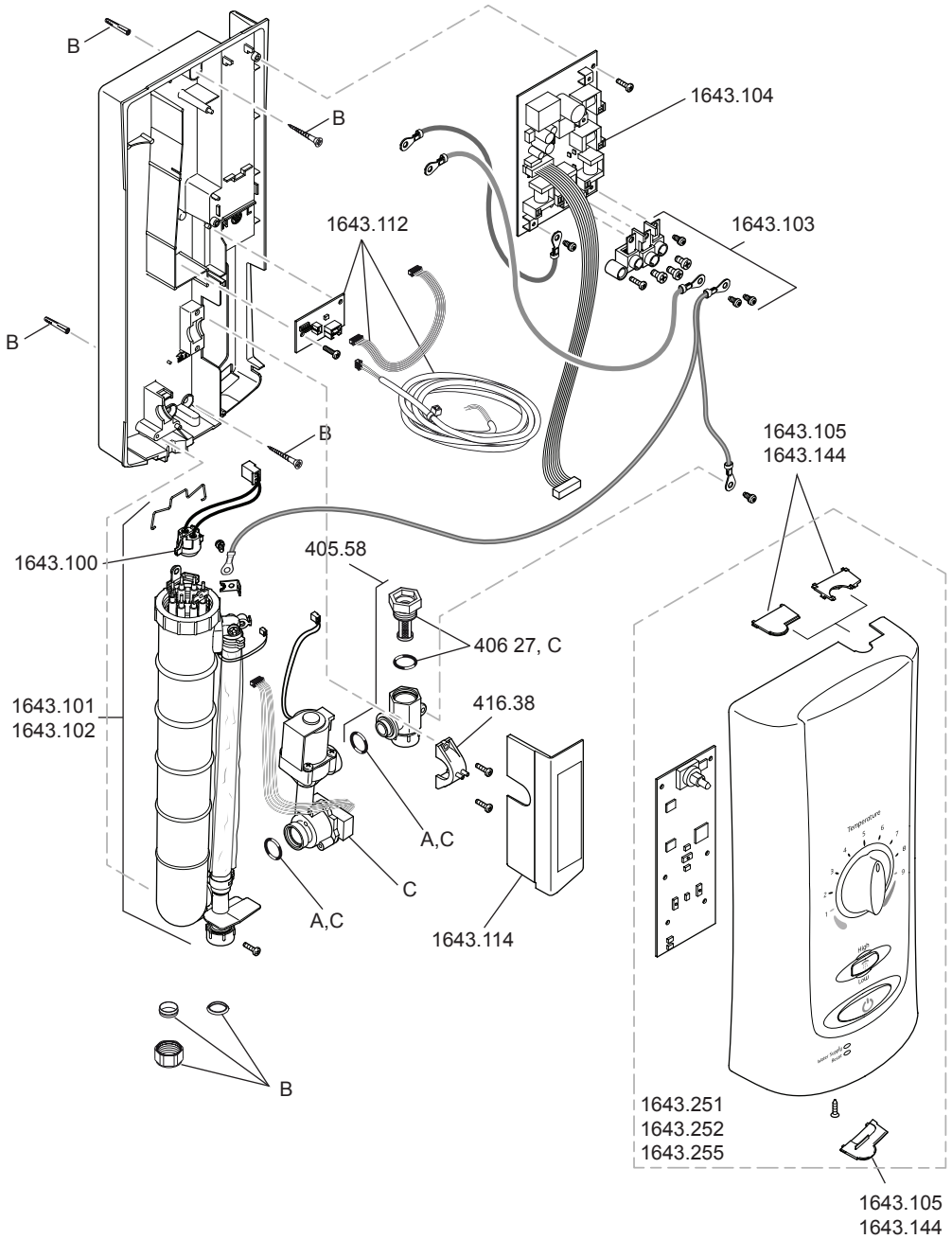

WIRING DIAGRAM

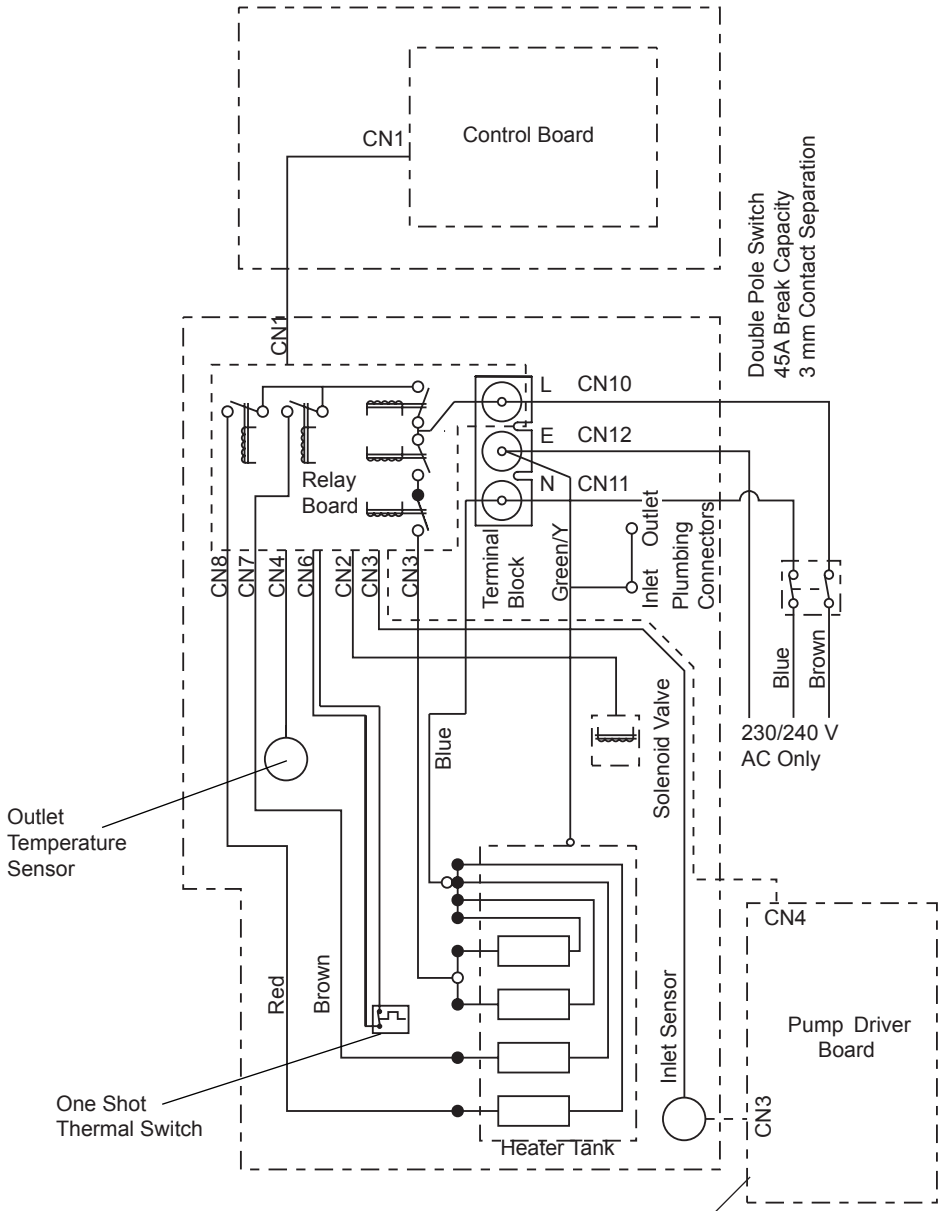

(Fitted to Standard Extra and Flex Extra models only.)

ACCESSORIES

Genuine Mira accessories can be purchased direct from Customers Services (our contact details can be found on the back cover of this guide) or from approved stockists or merchants.



Everclear Showerhead
White - 2.1616.030
Chrome - 2.1616.031

Mira's new Everclear range has been specially designed for hard water areas and reduces the risk of lime scale build up.

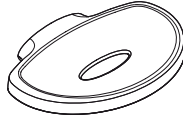

Wall Mounted Soap Dish
White - 1.1540.278
Chrome - 1.1540.279

Wall mounted for use anywhere in, or outside the showering area.

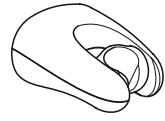

Logic Showerhead Holder
White - 2.1605.149
White/Chrome - 2.1605.150

An alternative to the traditional slide bar. Often a useful addition when positioned for the smaller members of the family.



Mira Standard Grab Bars
300 mm - 2.1605.070
450 mm - 2.1605.071
600 mm - 2.1605.072

Premium grade, highly polished, stainless steel grab bars.

Note! Must be installed onto a solid wall.

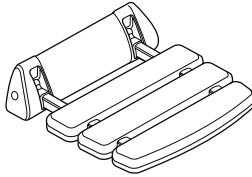

Shower Seat
White - 2.1536.128
White/Chrome - 2.1536.129

For use in or out of the showering area. Folds up when not in use. Maximum User Weight - 127 kg (20 stone) **Note!** Must be installed onto a solid wall.



Premium Shower Seat
White/Chrome - 2.1731.001
Grey/Chrome - 2.1731.002

Stylish, slim-line and robust shower seat for use in or outside of the shower area. Folds up when not in use. Maximum User Weight - 150 kg (23.5 stone) **Note!** Must be installed onto a solid wall.

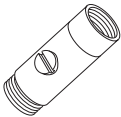

Outlet Double Check Valve (DCV-H)
Chrome - 1.0.110.55.1

An outlet double check valve, designed to prevent the back flow or back-siphonage of potentially contaminated water, through shower controls which are fitted with a flexible shower hose as part of the outlet shower fitting.

NOTES

CUSTOMER SERVICE

Guarantee

Your product has the benefit of our manufacturer's guarantee which starts from the date of purchase.

To activate this guarantee, please return your completed registration card, visit our website or free phone 0800 0731248 within 30 days of purchase (UK only).

Within the guarantee period we will resolve defects in materials or workmanship, free of charge, by repairing or replacing parts or product as we may choose.

If you have not previously activated the guarantee, you will be required to do so prior to the provision of assistance. If you do not activate your guarantee our Engineer will be entitled to charge full payment for the visit (Call out fee plus parts).

This guarantee is in addition to your statutory rights and is subject to the following conditions:

- The product must be installed and maintained in accordance with the instructions given in this user guide.
- Servicing must only be undertaken by us or our appointed representative. **Note!** if a service visit is required the product must be fully installed and connected to services.
- Repair under this guarantee does not extend the original expiry date. The guarantee on any replacement parts or product ends at the original expiry date.
- For shower fittings or consumable items we reserve the right to supply replacement parts only.

The guarantee does not cover:

- Call out charges for non product faults (such as damage or performance issues arising from incorrect installation, improper use, lack of maintenance, build up of limescale, frost damage, corrosion, system debris or blocked filters) or where no fault has been found with the product.
- Water or electrical supply, waste and isolation issues.
- Compensation for loss of use of the product or consequential loss of any kind.
- Damage or defects caused if the product is repaired or modified by persons not authorised by us or our appointed representative.
- Routine maintenance or replacement parts to comply with the requirements of the TMV 2 or TMV 3 healthcare schemes.

What to do if something goes wrong

If your product does not function correctly when you first use it, contact your installer to check that it is installed and commissioned in accordance with the instructions in this manual. Should this not resolve the issue, contact our Customer Services Team who will offer you or your installer advice and if applicable arrange for a Service Technician to call. If the performance of your product declines, check in this manual to see if simple home maintenance is required. If you require further assistance call our Customer Services Team.

Extended Guarantees

A selection of protection plans are available that enable you to cover repair bills for the life of your policy (excludes Eire). Ring 01922 471763 for more details.

Helpdesk Service

Our dedicated Customer Services Team is comprehensively trained and can offer help and advice, spare parts, accessories or a service visit. We will need you to have your model name or number, power rating (if applicable) and date of purchase. As part of our quality and training programme calls may be recorded or monitored.

Mira Showers Website (www.mirashowers.co.uk)

From our website you can register your guarantee, download additional user guides, diagnose faults, purchase our full range of accessories and popular spares, refer to our FAQ's and request a service visit.

Spares and Accessories

We maintain extensive stocks of genuine spares and accessories and aim to provide support throughout the product's expected life. Payment can be made by phone at time of order using most major Credit or Debit cards and we aim to despatch orders within two working days. Items purchased from us are guaranteed for 12 months from date of purchase. For safety reasons spares exposed to mains voltages should only be fitted by competent persons.

Returns – items can be returned within one month of date of purchase, providing that they are in good condition and the packaging is unopened. Please obtain authorisation from our Customer Services Team before return. We reserve the right to apply a 15% restocking charge.

Service / Repairs

We have a nationwide team of Service Technicians who can carry out all service or repair work to your product within the guarantee period and beyond. You have the assurance of a fully trained Mira Technician, genuine Mira spare parts and a 12 month guarantee on any chargeable work done.

Payment should be made directly to the Service Technician who will accept most major Credit or Debit cards.

To Contact Us

UK

Telephone: 0844 571 5000

www.mirashowers.co.uk

E-mail: technical@mirashowers.com

Fax: 01242 282595

By Post: Mira Customer Services Dept, Cromwell Road, Cheltenham, Gloucestershire, GL52 5EP

Eire

Telephone: 01 459 1344

E-mail: sales@modernplant.ie

Fax: Dublin 01 459 2329

By Post: Modern Plant Ltd (Dublin), Otter House, Naas Road, Clondalkin, Dublin 22

Mira is a registered trade mark of
Kohler Mira Limited.

The company reserves the right to alter
product specifications without notice.



FM 14648

mira

SHOWERS

Mira Advance Quick Start Guide



Advance
ATL THERMOSTATIC

To Turn Shower ON

1. Switch Electric On.

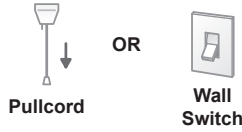

2. Button Turns Blue.



3. Press to Start Shower.



4. Turn to Change Temperature.

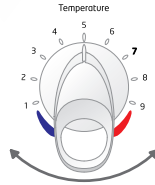

5. Press to Change Flow.



On some models
this button may
say 'Flow'.

6. Check Water Temperature
BEFORE Bathing.

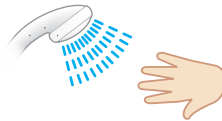

To Turn Shower OFF

1. Press to Stop Shower.



2.



CAUTION!
DO NOT switch electric off
until shower has stopped.

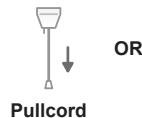

mira
SHOWERS



Advance
ATL THERMOSTATIC

Temperature

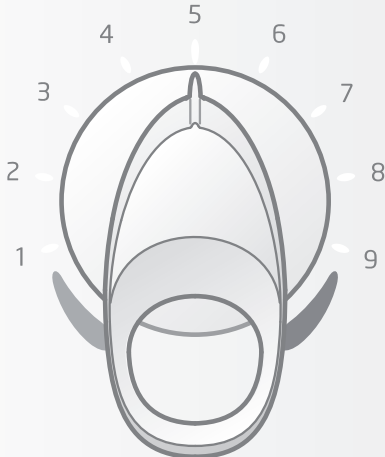

High

Flow

Low



Start - Stop

Water Supply ●

Reset ●

MIRA ADVANCE ATL

ADJUSTABLE TEMPERATURE LIMIT THERMOSTATIC

ELECTRIC SHOWER

User Guide

**These instructions are to
be left with the user**

CONTENTS

To The Customer	3
Guarantee	4
Patents and Design Registration.....	4
Important Safety Information	5
Operation	7
1. How your Shower Works.....	7
2. Using the Shower.....	9
3. Storing the Memory Presets (Memory Control Model only)	10
Shower Performance	11
Fault Diagnosis	12
Maintenance	15
Care Maintenance	15
BEAB CARE Requirements:	15
Customer Service	Back Cover

If you experience any difficulty with the operation of your new Electric Shower, then please refer to '**Fault Diagnosis**', before contacting Mira Showers. Our contact details can be found on the back cover of this guide.

TO THE CUSTOMER

Mira Advance ATL key features:

- Designed for safe and reliable control.
- Automatically adjusts to maintain constant temperature.
- Constantly monitors supply conditions.

Mira Advance ATL models covered by this guide

Product Variant	Adjustable Temperature Limit	Memory Push Button Feature	Extended Lever Control	Drain Pump Compatible	Model No.
Standard 9.0 kW	✓	✗	✗	✗	J97A
Standard 9.8 kW	✓	✗	✗	✗	J97B
Flex 9.0 kW	✓	✗	✓	✗	J97C
Flex 9.8 kW	✓	✗	✓	✗	J97D
Memory 9.0 kW	✓	✓	✗	✗	J97E
Memory 9.8 kW	✓	✓	✗	✗	J97F
Standard Extra	✓	✗	✗	✓	J97G
Flex Extra	✓	✗	✓	✓	J97H

The following separate drain kits are required for the 'Extra' models:

- SDP124T - Mira Whale Tray Kit (complete with 50 mm gully)
- SDP134T - Mira Whale Wet Floor Kit (complete with wet gully for vinyl)

This product must only be used with a Whale Shower Drain Pump (included in the kits listed above).

Please pass on this guide in the event of change of ownership of the installation site.

Guarantee

For **domestic installations**, Mira Showers guarantee the Mira Advance ATL against any defect in materials or workmanship for a period of **two years** from the date of purchase (shower fittings for one year).

For **non-domestic installations**, Mira Showers guarantee the Mira Advance ATL against any defect in materials or workmanship for a period of **one year** from the date of purchase.

For Terms and Conditions refer to the back cover of this guide.

Recommended Usage	
Domestic	✓
Light Commercial	✓
Heavy Commercial	✘
Healthcare	✓

Patents and Design Registration

Design Registration:	000738141: 0003, 0006, 0007, 0009
Patents:	GB: 2269466, 2270370, 2298478, 2298479, 2298481

IMPORTANT SAFETY INFORMATION

Caution!

1. Read all of these instructions and retain this guide for later use.
2. **WARNING: Do not** switch on if there is a possibility that the water in the appliance is frozen.
3. **DO NOT** operate this appliance if water is leaking from this appliance.
4. There are no user serviceable components beneath the cover of this appliance and **ELECTRICAL MAINS CONNECTIONS ARE EXPOSED IF THE COVER IS REMOVED**. Only a competent tradesperson should remove the cover.
5. The water supplies to this product must be isolated if the product is not to be used for a long period of time. If the product or pipework is at risk of freezing during this period they should also be drained of water.
6. Make sure that you fully understand how to operate this shower and make sure that it is properly maintained in accordance with the instructions given in this manual.
7. Rapid/Excessive movement of the flow and/or temperature control levers may result in momentary unstable blend temperatures.
8. Care is required when adjusting flow or temperature, make sure that the temperature has stabilised.
9. This appliance is not intended for use by persons (including children) with reduced physical, sensory or mental capabilities, or lack of experience and knowledge, unless they have been given supervision or instruction concerning the use of the appliance by a person responsible for their safety.
10. Children should be supervised to make sure that they do not play with the appliance.
11. Sunburn or skin conditions can increase your sensitivity to hot water. Make sure that you set the shower to a cooler temperature.
12. If any of the following conditions occur, isolate the electricity and water supplies and refer to '**To Contact Us**', on the back page of this guide.
 - 12.1. If the cover is not correctly fitted and water has entered the shower case.
 - 12.2. If the case is damaged.
 - 12.3. If the shower begins to make an odd noise, smell or smoke.
 - 12.4. If the shower shows signs of a distinct change in performance, indicating a need for maintenance.
 - 12.5. If the shower is frozen.
13. Switch off the appliance at electrical isolating switch when not in use. This is for safety and is recommended with all electrical appliances.
14. **DO NOT** position the handset to spray water directly on to the appliance. E.g. when cleaning shower control.
15. **DO NOT** fit any form of outlet flow control (e.g. trigger handsets) as the outlet

acts as a vent for the heater tank body. Only Mira recommended outlet fittings should be used.

- 16.** When this appliance has reached the end of its serviceable life, it should be disposed of in a safe manner, in accordance with current local authority recycling, or waste disposal policy.
- 17.** Please pass this guide on in the event of a change of ownership of the installation site.

OPERATION

1. How your Shower Works

Hot water is produced by passing cold water through a heating tank.

The shower constantly monitors the following conditions:

- The incoming cold water temperature.
- The showering temperature.
- The flow rate of water.
- The current user settings.

The flow rate may automatically adjust to maintain the current temperature setting. As part of this process, a series of 'clicks' may be heard, this is a normal part of the operation when the shower is in use.

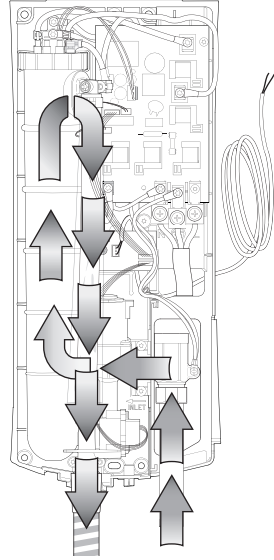

The showering temperature is adjusted by turning the **Temperature Control Dial**, which varies the flow of cold water passing over the elements. The slower the rate of flow, the warmer the shower and vice versa. Care is required when adjusting flow or temperature, make sure that the temperature has stabilised.

Note! Rapid/Excessive movement of the flow and/or temperature control levers may result in momentary unstable blend temperatures.

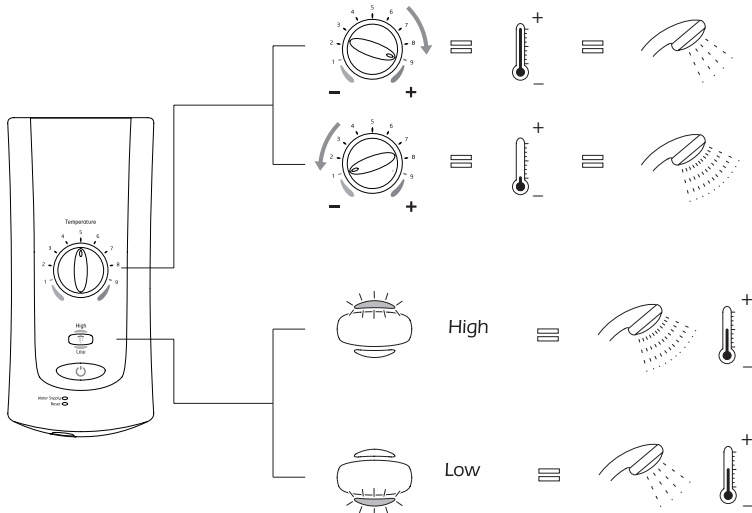

As outlined in section '**Shower Performance**', certain conditions can cause the shower's performance to vary. The most common of these conditions is detailed below:

The Effect of Other Water Devices

Temporary changes in supply conditions can cause reduced flow performance. The selected flow setting may not be available until supply returns to normal.

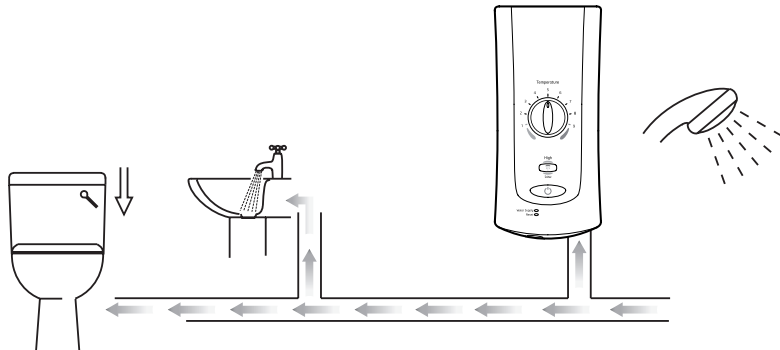

Thermostatic Performance

To maintain thermostatic performance, the shower may override the selected flow condition. The selected flow indicated does **NOT** change.

Unattended Operation

The appliance has a built in 'Shower Stop' timer to protect from accidental unattended operation. This feature automatically switches the shower **off** after **40 minutes** of continuous use. Normal operation is restored by re-selecting the **Start/Stop** button.

Note! High cold water mains supply pressures and high shower temperatures will cause a slight hissing sound to be heard from the appliance whilst it is operating. This is quite normal and does not indicate that there is a fault with the shower.

Rapid or excessive movement of the flow and temperature control levers may result in momentary high or unstable blend temperatures. To adjust flow or temperature operate controls by turning gradually and allowing 10-15 seconds to stabilise checking the temperature before entering the shower.

2. Using the Shower

Refer to section: 'Important Safety Information' first.

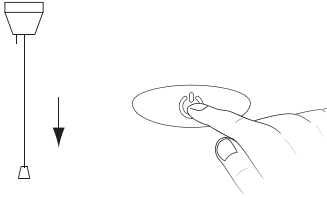

1. With the electrical supply turned on, push **Start/Stop**.

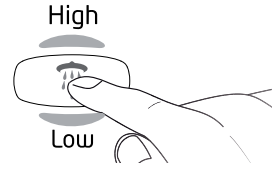

2. Select the desired flow by pushing either once or twice.



3. Check water temperature before entering shower.

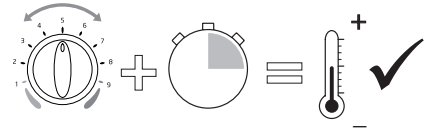

4. Allow 10-15 seconds for any temperature adjustments to reach the showerhead.



5. **Powering down the appliance:**

Caution! Isolating power without shutting down the appliance using the **Start/Stop** button, and not waiting for the flow to stop, will result in a temporary malfunction. **Always follow the correct shut down procedure.**

6. Push **Start/Stop** to turn off the appliance. The pulsing light and "beep" indicates that the appliance is shutting down.

Important! DO NOT isolate the power to the appliance.

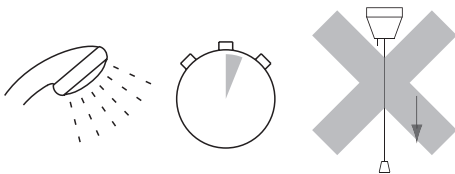

7. The shower will purge water from its tank for a few seconds.

Important! DO NOT isolate the power to the appliance.



8. Wait until the water has stopped flowing and turn off the power to the appliance, residual water may drain over a few minutes.

3. Storing the Memory Presets (Memory Control Model only)

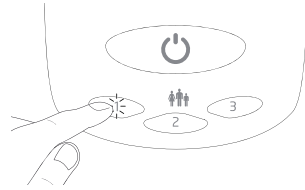
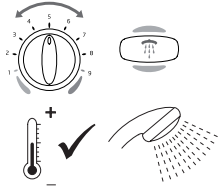

1. Set the shower to the desired temperature and flow.
2. Push and hold down the desired memory button. A "beep" and flashing light will indicate the setting has been stored successfully.

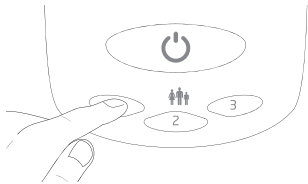

3. To retrieve a stored setting, push the desired memory button when the shower is either on or off.

SHOWER PERFORMANCE

What affects shower performance?

The shower's top priority is to keep the desired water temperature constant. To maintain this temperature, the shower may have to automatically change the rate of water flowing through the appliance. Any of the following conditions can cause the shower to change the flow rate (force of the shower) in order to keep the temperature constant. Most changes are minor and will go unnoticed.



Seasonal changes affecting water supply temperature.

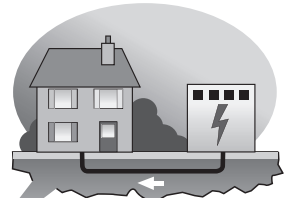

Changes of incoming supply voltage.



Changes in Flow Rate
(force of shower).

Temperature remains constant.



Changes of incoming supply pressure.

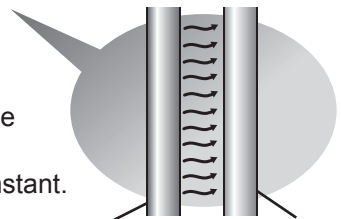

hot pipe
mains cold pipe

Heat transfer due to position of mains cold water pipe.

E.g.

- Positioned next to hot water pipe.
- Routed through heated area such as loft or airing cupboard.

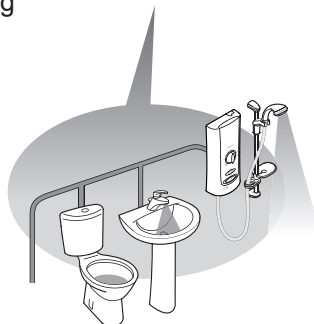

Mains cold water draw off, e.g. toilet, wash basin etc.

FAULT DIAGNOSIS

1. User Troubleshooting Guide

The Mira Advance ATL electric shower is fully performance tested after assembly. In the unlikely event that you experience problems with the appliance, then the following procedures will enable basic troubleshooting before contacting the competent tradesperson responsible for installing the shower.

Warning! There are no user serviceable components beneath the cover of the appliance.

Only a competent tradesperson should remove the front cover. We recommend any maintenance work is carried out by a Mira service Engineer or qualified tradesperson.

Reset the Shower

This is the first solution to the appliance not operating (i.e. the reset light is illuminated).

DO NOT switch on the appliance if there is a possibility that the water in the shower is frozen!

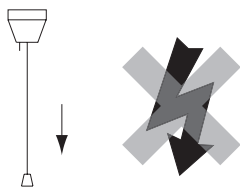

1. Isolate electrical supply.

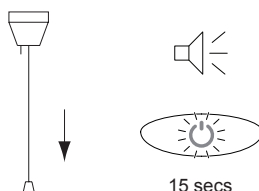

2. Restore power to the appliance. The appliance may "beep" and the **Start/Stop** button pulse for 15 seconds.









3. Wait for the **Start/Stop** button to stop pulsing, then operate the appliance, refer to section: '**Operation, Using the Shower**'.
4. If the failure continues after resetting, there are a few basic supply checks that can be performed.

Basic Supply Checks:

- Check there is electricity still supplied to the appliance (lights and/or beeps will confirm this). If in any doubt, contact a qualified electrician. If a short power cut has occurred during use, the shower will automatically reset as above and be ready when the blue light stops pulsing. Check all plumbing isolator valves to the shower are fully open.
- A section of supply pipe may be preheating the cold water supply to the shower e.g. cold water supply pipe is running through a loft or is adjacent to hot water pipes.
- A section of supply pipe is frozen. Allow to thaw and insulate the pipe.
- Recommission the shower (refer to section: '**Commissioning**' in the '**Mira Advance Installation Guide**').
- In rare cases, **or if the unit has been powered down incorrectly**, hot water may be retained within the shower causing a failure to continue even though the underlying cause may have been corrected. Allowing the water to cool for approximately 20 minutes before use should clear this error.

If a failure still continues after all of these checks are complete, and the shower has once again been reset, and a solution has not been identified in the fault diagnosis table, then contact a competent tradesperson who can further diagnose the fault.

No light ○ Flashing light  Solid light ●

Indicator Display	Possible Cause/Rectification
<p>No lights or beeps</p>	<p>Problem with Electrical supply.</p> <ol style="list-style-type: none"> 1. Make sure there is power to the appliance. 2. Reset the shower. 3. Contact qualified electrician to investigate the cause.
<p>Shower temperature is not hot enough.</p>	<p>Maximum temperature is set too low.</p> <ol style="list-style-type: none"> 1. Adjust Maximum Temperature, refer to section: 'Set Maximum Temperature and Commissioning Cycle' in the 'Mira Advance ATL Electric Shower Installation Guide'.
<p>Water Supply- OR  Reset </p>	<p>Problem with incoming water supply. Hose or showerhead blocked. Temperature is too high and/or pressure is too low.</p> <ol style="list-style-type: none"> 1. Water supply may correct itself within a few minutes. 2. The showerhead may be blocked, refer to the fault diagnosis section in your shower fittings installation and user guide. 3. The shower hose is kinked or blocked. 4. If the warning persists during further use, check all isolator valves are fully open and Reset/Recommission the shower. 5. If the warning still persists, there is a problem with the water supply. Contact a competent tradesperson who can further investigate the cause.
<p>Water Supply  Reset- OR </p>	<p>Automatic shutdown to protect against unsafe showering. Caused by problem with either the appliance or the electrical/water supply.</p> <ol style="list-style-type: none"> 1. Reset the shower.
	<p>Appliance has been incorrectly shut down.</p> <ol style="list-style-type: none"> 1. If a 2 second beep is heard and the Start / Stop light pulses after the power supply is restored to the shower this indicates incorrect shower shutdown on previous use. The pulsing light will stop after 20 seconds and the shower can then be used normally.

MAINTENANCE

User Maintenance - Cleaning

Many household cleaners contain abrasives and chemical substances, and should not be used for cleaning plated or plastic fittings. These finishes should be cleaned with a mild washing up detergent or soap solution, and then wiped dry using a soft cloth.



Note! If any of the button lights are flashing or pulsing continuously (in excess of 15 seconds) this may indicate that the button is stuck, this can be avoided by keeping the unit clean.

Poor shower performance can be avoided by cleaning the spray plate. Use thumb or soft cloth to wipe rubber nozzles. The showerhead must be descaled regularly to stop the showerhead getting blocked.



CARE MAINTENANCE

BEAB CARE Requirements:

Routine maintenance is required for all BEAB CARE installations. The Inlet Filter shall be cleaned or replaced after the first 6 months of use. This shall then be repeated every 12 months. Cleaning the Inlet Filter should be performed by a competent tradesperson only.

Year	Date	Signature
6 Months		
1		
2		
3		
4		
5		
6		
7		
8		

CUSTOMER SERVICE

Guarantee

Your product has the benefit of our manufacturer's guarantee which starts from the date of purchase.

To activate this guarantee, please return your completed registration card, visit our website or free phone 0800 0731248 within 30 days of purchase (UK only).

Within the guarantee period we will resolve defects in materials or workmanship, free of charge, by repairing or replacing parts or product as we may choose.

If you have not previously activated the guarantee, you will be required to do so prior to the provision of assistance. If you do not activate your guarantee our Engineer will be entitled to charge full payment for the visit (Call out fee plus parts).

This guarantee is in addition to your statutory rights and is subject to the following conditions:

- The product must be installed and maintained in accordance with the instructions given in this user guide.
- Servicing must only be undertaken by us or our appointed representative. **Note!** if a service visit is required the product must be fully installed and connected to services.
- Repair under this guarantee does not extend the original expiry date. The guarantee on any replacement parts or product ends at the original expiry date.
- For shower fittings or consumable items we reserve the right to supply replacement parts only.

The guarantee does not cover:

- Call out charges for non product faults (such as damage or performance issues arising from incorrect installation, improper use, lack of maintenance, build up of limescale, frost damage, corrosion, system debris or blocked filters) or where no fault has been found with the product.
- Water or electrical supply, waste and isolation issues.
- Compensation for loss of use of the product or consequential loss of any kind.
- Damage or defects caused if the product is repaired or modified by persons not authorised by us or our appointed representative.
- Routine maintenance or replacement parts to comply with the requirements of the TMV 2 or TMV 3 healthcare schemes.

What to do if something goes wrong

If your product does not function correctly when you first use it, contact your installer to check that it is installed and commissioned in accordance with the instructions in this manual. Should this not resolve the issue, contact our Customer Services Team who will offer you or your installer advice and if applicable arrange for a Service Technician to call. If the performance of your product declines, check in this manual to see if simple home maintenance is required. If you require further assistance call our Customer Services Team.

Extended Guarantees

A selection of protection plans are available that enable you to cover repair bills for the life of your policy (excludes Eire). Ring 01922 471763 for more details.

Helpdesk Service

Our dedicated Customer Services Team is comprehensively trained and can offer help and advice, spare parts, accessories or a service visit. We will need you to have your model name or number, power rating (if applicable) and date of purchase. As part of our quality and training programme calls may be recorded or monitored.

Mira Showers Website (www.mirashowers.co.uk)

From our website you can register your guarantee, download additional user guides, diagnose faults, purchase our full range of accessories and popular spares, refer to our FAQ's and request a service visit.

Spares and Accessories

We maintain extensive stocks of genuine spares and accessories and aim to provide support throughout the product's expected life. Payment can be made by phone at time of order using most major Credit or Debit cards and we aim to despatch orders within two working days. Items purchased from us are guaranteed for 12 months from date of purchase. For safety reasons spares exposed to mains voltages should only be fitted by competent persons.

Returns – items can be returned within one month of date of purchase, providing that they are in good condition and the packaging is unopened. Please obtain authorisation from our Customer Services Team before return. We reserve the right to apply a 15% restocking charge.

Service / Repairs

We have a nationwide team of Service Technicians who can carry out all service or repair work to your product within the guarantee period and beyond. You have the assurance of a fully trained Mira Technician, genuine Mira spare parts and a 12 month guarantee on any chargeable work done.

Payment should be made directly to the Service Technician who will accept most major Credit or Debit cards.

To Contact Us

UK

Telephone: 0844 571 5000

www.mirashowers.co.uk

E-mail: technical@mirashowers.com

Fax: 01242 282595

By Post: Mira Customer Services Dept, Cromwell Road, Cheltenham, Gloucestershire, GL52 5EP

Eire

Telephone: 01 459 1344

E-mail: sales@modernplant.ie

Fax: Dublin 01 459 2329

By Post: Modern Plant Ltd (Dublin), Otter House, Naas Road, Clondalkin, Dublin 22

Mira is a registered trade mark of
Kohler Mira Limited.

The company reserves the right to alter
product specifications without notice.



FM 14648

mira

SHOWERS